



Design Guide 2024

# PowerHap Starter Kit



[www.tdk-electronics.tdk.com](http://www.tdk-electronics.tdk.com)

# PowerHap Starter Kit

## Design Guide

### TABLE OF CONTENTS

General purpose.....	2
Mechanical stack overview.....	3
The actuators: PowerHap 1204H018V060 and PowerHap 1313H018V120.....	3
The seamless button.....	4
Component details .....	5
Extra: Measurement example regarding overlay stiffness .....	8
Extra: Replaceable overlay materials.....	8
Round design .....	9
Component details .....	10
Extra: Pivot plate mechanics.....	12
Extra: Exchangeable PowerHap .....	12
Using the Starter Kit – The electronic HW and GUI SW .....	13
Haptic measurements.....	14
Appendices and application notes.....	15
PowerHap data sheet .....	15
Design support: Application notes and design files .....	15
Contact Information .....	15
Revision history .....	15
Cautions and warnings .....	16

# PowerHap Starter Kit

## Design Guide

### GENERAL PURPOSE

The purpose of the PowerHap Starter Kit (PN: Z63000Z2910Z1Z89) is to

- easily convey a first impression of TDK's PowerHap piezo actuators
- show how the mechanical integration works
- provide a reference design, which can be adapted to various applications.

Mechanical designers and engineers will obtain the basic information required to design their haptic application with PowerHap actuators from this document.



#### Caution!

The kit described is an evaluation kit intended for use in a laboratory setting only. It operates at voltages up to 100 V. This board must be operated by qualified and skilled personnel familiar with all applicable safety standards.

The PowerHap Starter Kit consists of:

- Seamless button assembly (incl. PowerHap 1204H018V060 and PowerHap 1313H018V120)
- Round button assembly (incl. PowerHap 1204H018V060)
- Boréas Technologies BOS1921-Kit driver board
- Extra PowerHap 1204H018V060 and PowerHap 1313H018V120 (incl. FPC connection cable)
- USB cable
- Quick start user guide



Picture 1: The PowerHap Starter Kit with Boreas 1921 Driver board inside its packaging box

# PowerHap Starter Kit

## Design Guide

### MECHANICAL STACK OVERVIEW

The following chapter describes the mechanical design of the two included haptic button assemblies, the seamless button assembly, and the round button assembly. The description consists of a general overview of each part as well as essential details of all the sub-materials to facilitate the reproduction of both assemblies.

First, however, the two PowerHap actuators used are introduced.

### THE ACTUATORS: POWERHAP 1204H018V060 AND POWERHAP 1313H018V120

The Starter Kit uses two of TDK's most common haptic actuators: PowerHap 1204H018V060 and PowerHap 1313H018V120 (later referred to as PowerHap 1204 and PowerHap 1313). The two actuators are suitable for a large variety of applications. Typically, PowerHap 1204 is used when haptics are needed in a narrow space (for example, the side buttons of a mobile phone) and PowerHap 1313 is used when slightly more haptic power is required and space constraints are not an issue, e. g. a small group of buttons in a car or a medium-sized display.

Figure 1 shows the two PowerHap actuators. Note that the PowerHap 1204 has a dimple designed into its bows, and the dimple functions as an internal backstop. Due to its backstop, the PowerHap 1204 actuator can withstand up to 80 N of compressive force.



Figure 1: PowerHap 1313H018V120 and PowerHap 1204H018V060

Table 1 shows the basic performance characteristics of the two PowerHap actuators being described:

PowerHap Type	Size [mm]	Capacitance [ $\mu$ F, 1 kHz, 1V]	Voltage [V]	Max displacement [ $\mu$ m]	Max g [g, with 100 g]
<a href="#">1204H018V060</a>	12 x 4 x 1.74	0.5	0...+95	27 (0...60 V) 43 (0...95 V)	6.9 10.3
<a href="#">1313H018V120</a>	12.7 x 12.7 x 1.8	0.9	0...+120	65 (0...120 V)	13

Table 1: The basic performance characteristics of the two PowerHaps used in the Starter Kit



# PowerHap Starter Kit

## Design Guide

### THE SEAMLESS BUTTON

The following chapter reviews the mechanical integration of the seamless button. Figure 2 shows an exploded view and on the next page, a cross-section view can be seen in figure 3.

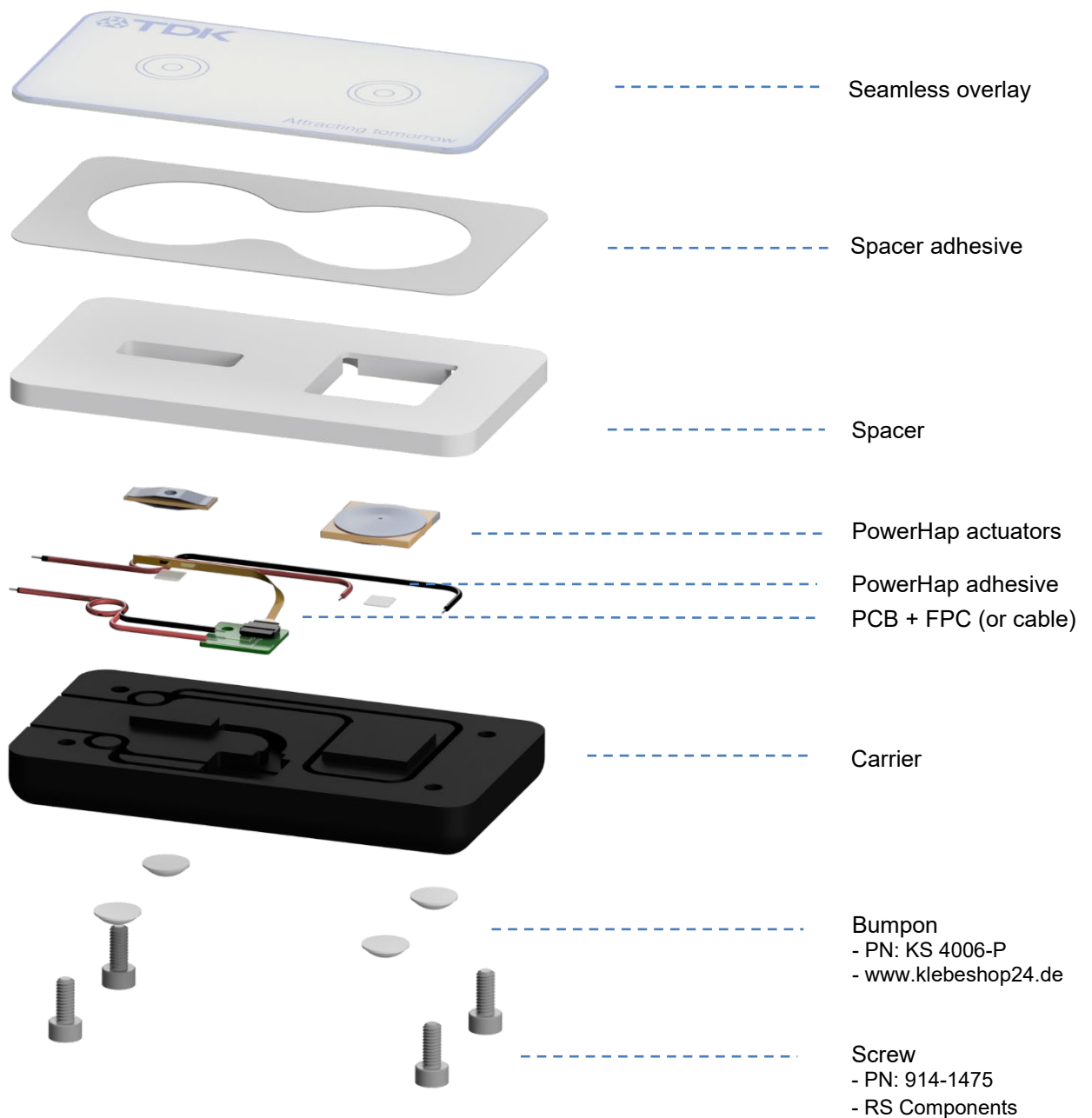

**Figure 2:** Exploded view of the seamless button

# PowerHap Starter Kit

## Design Guide

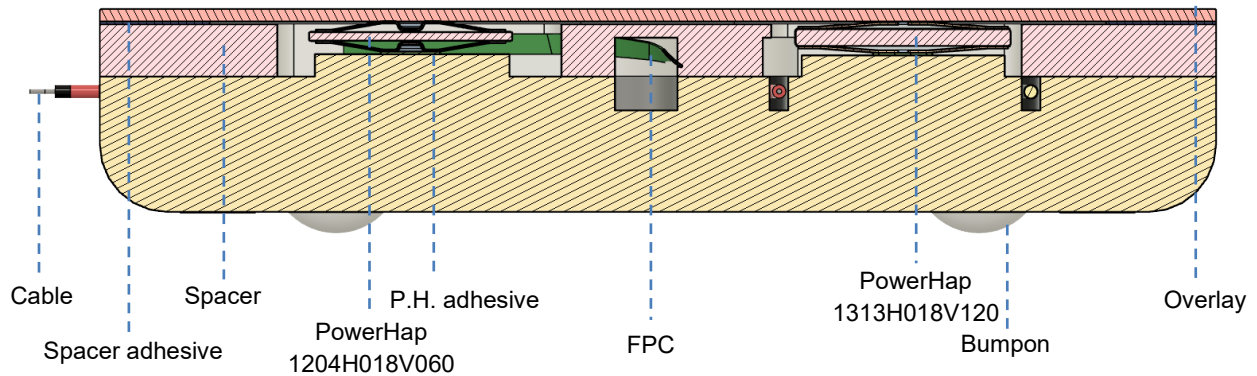

Figure 3: Seamless button cross section view

**Assembly step file** Seamless\_Button\_Z01\_Ind.00

Table 2: Supportive documentation to the seamless button assembly

### COMPONENT DETAILS

All essential BOM parts are explained in the following chapter.

#### 1 Seamless Overlay

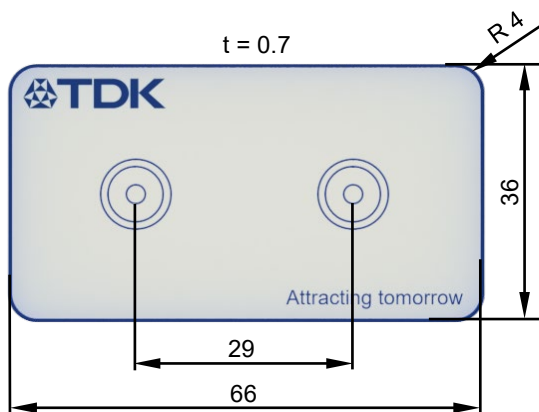

In a seamless design, the haptic experience is based on bending/deforming the overlay in a specific location. Therefore, flexible overlays give stronger haptic feedback.

In practice, the seamless overlay can consist of any material, provided the material is flexible enough. Typical materials include polycarbonate, aluminum, or wood, for example. The Starter Kit uses a screen-printed polycarbonate overlay of 0.7 mm thickness.

Note that the design is prepared so that one can experiment with different overlay options to understand their influence on the haptic feedback.

<b>Starter Kit material</b>	Polycarbonate 0.7 mm
<b>Material options</b>	Aluminum ≤ 0.3 mm, Wood ≤ 1.0 mm (the thinner the better from a haptic perspective)

Table 3: Seamless overlay materials

# PowerHap Starter Kit

## Design Guide

### 2 Spacer adhesive

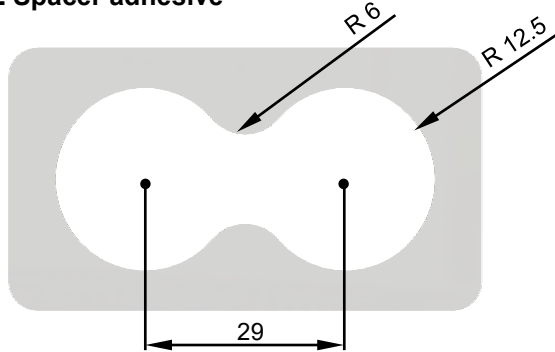

The spacer adhesive has two main functions: firstly, it bonds the spacer and the overlay together. Secondly, it also has a significant influence on the stiffness, hence the haptic feedback strength, of the overlay due to the size of the cutout area.

Note that the spacer adhesive also influences the pre-pressure on top of the PowerHap, therefore it is crucial to use the specified adhesive thickness.

<b>Starter Kit material</b>	3M 200MP 467 7956 (thickness = 150 $\mu\text{m}$ )
<b>Material options</b>	Most pressure-sensitive adhesives with defined thicknesses

Table 4: Spacer adhesive materials

### 3 Spacer

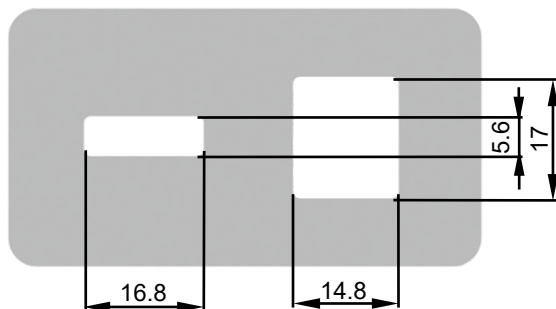

The purpose of the spacer is to facilitate easy surface replacements using a screw connection.

<b>Material used</b>	Milled aluminum (thickness = 5 mm)
----------------------	------------------------------------

Table 5: Spacer materials

### 4 Carrier



The carrier stows all components and cables and elevates the PowerHap in such a way that an appropriate distance between overlay and PowerHap can be achieved.

<b>Material used</b>	Milled Polyoxymethylene (POM) (thickness = 5 mm)
----------------------	--

Table 6: Carrier materials

# PowerHap Starter Kit

## Design Guide

### 5 FPC, PCB, and ZIF connector

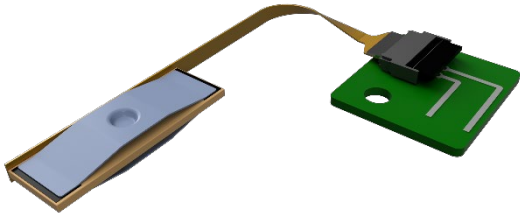

The PowerHap 1204 is pre-assembled to an FPC to demonstrate a final integration concept. To connect the FPC a 4 pin ZIF connector of 0.5 mm pitch from Hirose is used, the smallest connector found where the usage of up to 120 V is supported by the supplier.

Note: the IPC-2221 standard requires a clearance/creepage distance for 51 to 100 V peak voltages to be 0.13 mm for coated and 0.6 mm for uncoated areas. For 150 V, it is 0.4 mm coated / 0.6 mm uncoated. In the Starter Kit, the IPC-2221 standard is followed by using only the two outermost pins of the ZIF connector, i.e., pin 1 and pin 4.

<b>Connector</b>	FH34D-4S-0.5SH(50) from Hirose
<b>FPCs</b>	StarterKit_FPC_Ind.00.zip / 6D-BVZ-PZ-1204-SK-FPC.pdf
<b>PCB</b>	StarterKit_PCB_Ind.00.zip

Table 7: FPC, PCB, and ZIF connector materials and supportive documentation

### 6 PowerHap Adhesive

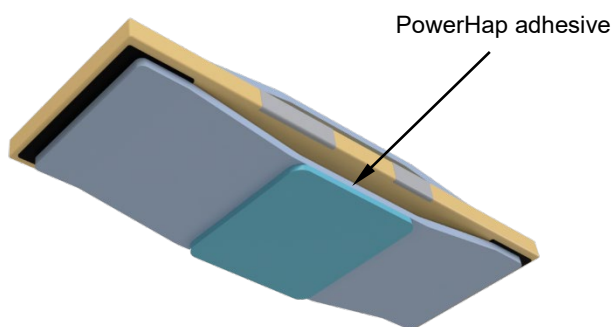

The adhesive underneath the PowerHap is used to keep the PowerHap in place. It is also important to control the pre-pressure with the adhesive thickness.

In the seamless button it has been chosen to only use an adhesive underneath the PowerHap because of two reasons: Firstly, the haptic actuation of the PowerHap is 'outwards', and within the Starter Kit assembly the PowerHap is clamped/under pre-pressure. Secondly, by not using an adhesive on the top side of the PowerHap the flexibility to exchange overlays remain.

<b>Adhesive used</b>	3M 200MP 7953, 50 µm thick, double-sided PSA
<b>Material option</b>	3M 200MP 7956 150 µm thick, incl. PET carrier, and is easier to handle
<b>Adhesive size</b>	3 mm x 3 mm x 0.05 mm

Table 8: PowerHap adhesive materials



# PowerHap Starter Kit

## Design Guide

### EXTRA: MEASUREMENT EXAMPLE REGARDING OVERLAY STIFFNESS

In a seamless button design, the intensity of the haptic feedback largely depends on the overlay's stiffness. The overlay stiffness is governed by the overlay material, the material thickness, and the cutout size in the underlying spacer adhesive.

Figure 4 depicts three overlay deflection measurements. The basic configuration reflects the dimensions used in the seamless button. The changing parameters are: overlay material of PET 0.75 mm vs. PET 0.5 mm and adhesive cutout of  $\varnothing$  25 mm vs.  $\varnothing$  15 mm.

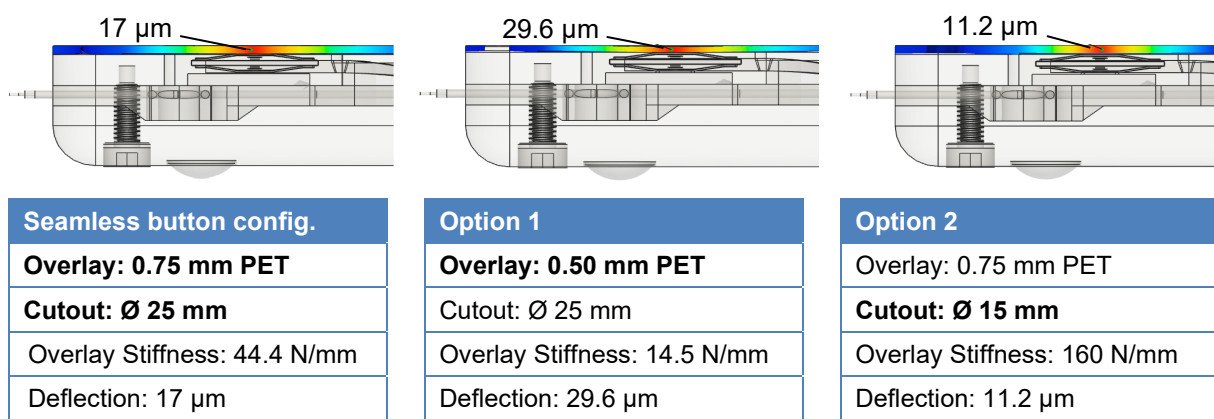
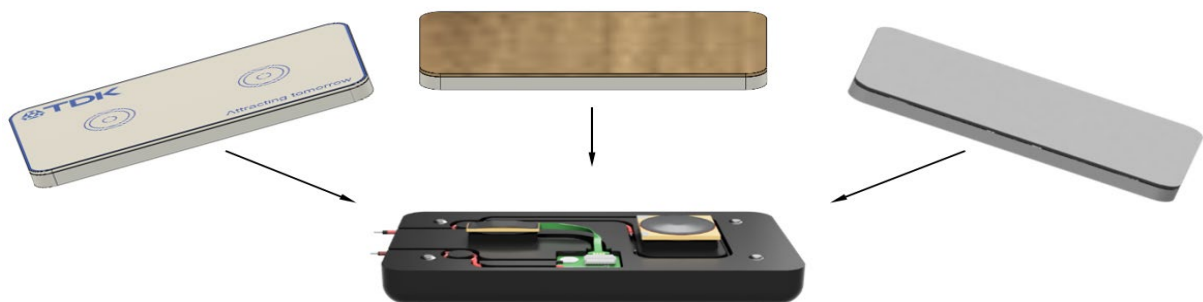

**Figure 4:** Overlay deflection measurements as a function of material thickness and adhesive cutout

In figure 4, 'option 1' gives the most deflection, hence this option would also provide the strongest haptic feedback. This is caused by the low stiffness of 14.5 N/mm, which the actuator must work against. Comparing this deflection to the seamless button configuration and option 2 the values point out that the deflection, and hence the haptic performance, is directly related to the stiffness of the bending part. The force of the PowerHap is proportional to the boosting voltage used and the actuator's distance of elongation. See the force-stroke diagrams in the PowerHap data sheet to understand each actuator's actual force.

### EXTRA: REPLACEABLE OVERLAY MATERIALS

The seamless button allows for the easy replacement of overlay materials and overlay thicknesses.



**Figure 5:** Replacing the overlay material in order to experience their influence on the haptic feedback is easy

# PowerHap Starter Kit

## Design Guide

### ROUND DESIGN

In the following chapter, the mechanical integration of the round button is reviewed.

Figure 6 shows an exploded view, and on the next page, a cross-section view can be seen in figure 7.

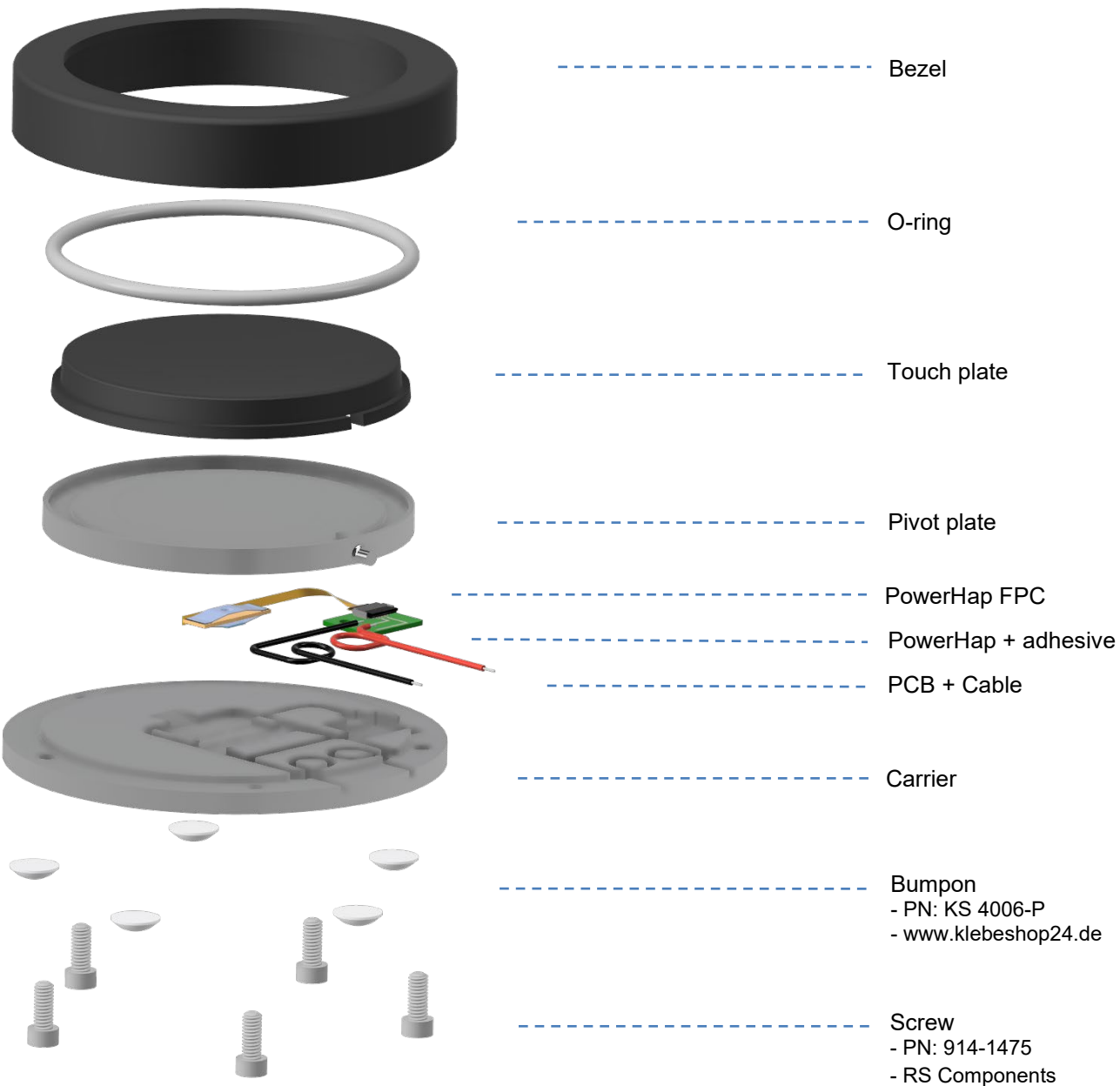

Figure 6: Exploded view of the round button

# PowerHap Starter Kit

## Design Guide

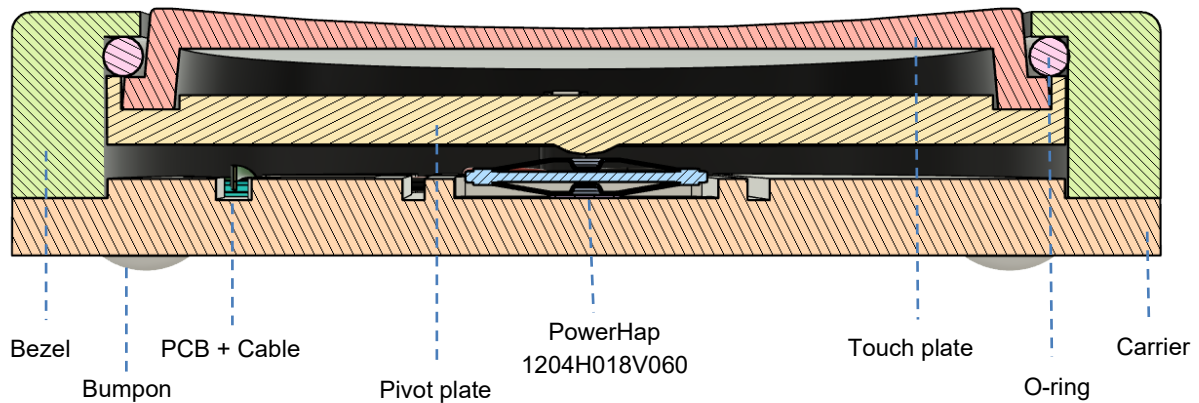

Figure 7: Round Button cross-section view

<b>Assembly step file</b>	Round_Button_Z01_Ind.01
---------------------------	-------------------------

Table 9: Supportive documentation for the round button assembly

### COMPONENT DETAILS

#### 1 Bezel

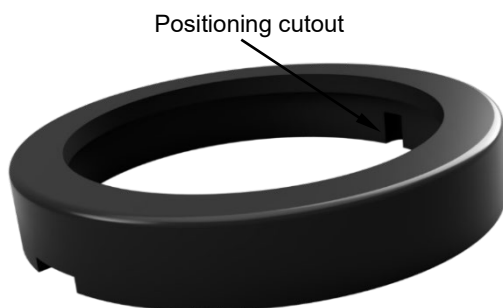

The bezel holds the moving parts in position and ensures a preload on the PowerHap.

<b>Material used</b>	Milled Polyoxymethylene (POM)
----------------------	-------------------------------

Table 10: Bezel materials

#### 2 O-ring



The O-ring provides the necessary level of stiffness and tolerance while also allowing the touch plate to move.

<b>Material used</b>	Nitrite rubber (NBR), shore hardness A50
----------------------	--

Table 11: O-ring materials

# PowerHap Starter Kit

## Design Guide

### 3 Touch plate



A commercially available round trackpad from Cirque is used as a touch plate. The Cirque trackpad was used for its pleasant surface feel and the option to utilize the capacitive touch sensing at a later stage. Hence, currently, the trackpad functionality is not implemented into the Starter Kit.

If you wish to utilize the capacitive touch option, we recommend that you contact Cirque.

<b>Data sheet</b>	Cirque / TM040040 Trackpad Specification
<b>Supply source</b>	<a href="http://www.mouser.com">www.mouser.com</a> / PN: 355-TM0400402024-303

Table 12: Touch plate materials

### 4 Pivot plate

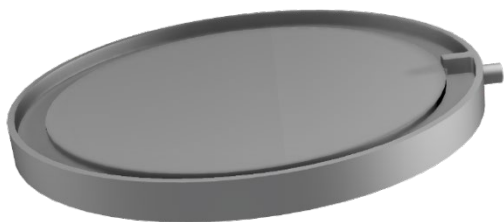

The pivot plate comes into contact with the PowerHap and acts as a lever when interacting at the edges of the touch plate. Therefore, a high degree of rigidity is required to transmit the forces and movements of the PowerHap.

<b>Material used</b>	Milled aluminum
----------------------	-----------------

Table 13: Pivot plate materials

### 5 Carrier



The carrier stows all components and cables, as well as elevates the PowerHap in such a way that the appropriate distance between the pivot plate and the PowerHap can be achieved.

<b>Material used</b>	Milled aluminum
----------------------	-----------------

Table 14: Carrier materials

# PowerHap Starter Kit

## Design Guide

---

### EXTRA: PIVOT PLATE MECHANICS

Within the round button the pivot plate acts as a lever (or mechanical amplifier). When pressing the very edges of the touch plates the mechanical movement is amplified (2:1), which can be recognized to some extent from the touch trigger sensitivity, the mechanical flexibility, and the somewhat stronger haptic feedback.

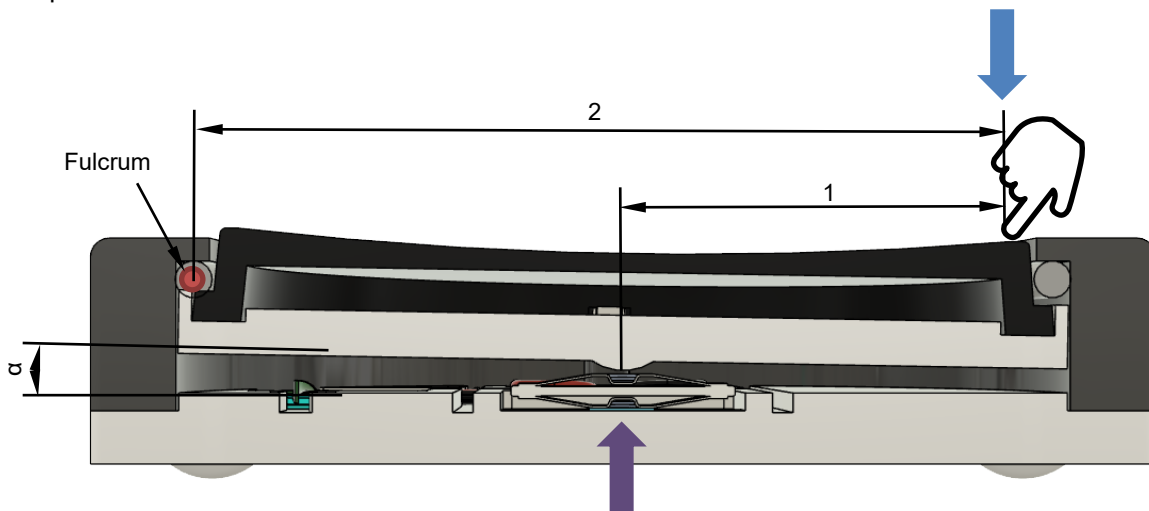

**Figure 8:** The pivot plate acting as a lever inside the round button

Besides the lever mechanism, the mass of the moving components also influences the strength of the haptic feedback. Increasing weight results in stronger feedback. The round button moves a mass of 15g. This should be the minimum weight in similar applications when targeting round button haptics.

---

### EXTRA: EXCHANGEABLE POWERHAP

The seamless button is equipped with one PowerHap 1204 and one PowerHap 1313. In contrast, the round button allows for easy exchanges between the two PowerHaps, as the two PowerHaps are identical in height.

The regular Starter Kit is delivered with the PowerHap 1204 assembled inside the round button, and a PowerHap 1204 and a PowerHap 1313 as spare material.

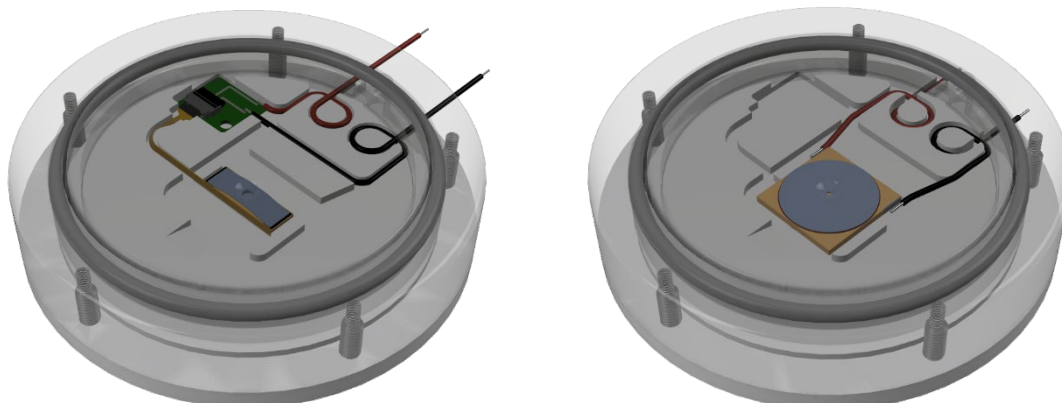

**Figure 9:** The round button can be used with either PowerHap 1204H018V060 or PowerHap 1313H018V120



# PowerHap Starter Kit

## Design Guide

### USING THE STARTER KIT – THE ELECTRONIC HW AND GUI SW

The PowerHap Starter Kit utilizes the Boréas Technologies BOS1921-KIT Development platform. The supplied Boréas kit is pre-programmed for the seamless button and the round button, so that it is possible to experience sensing and haptics with the PowerHap actuators out-of-the-box.

Figure 10 shows how to connect the Starter Kit. Both buttons can be used with either channel A or channel B. As a default setting, channel A provides a sharp 'click' feedback and channel B offers more 'buzzing' haptics. The exact default parameters are explained in figure 11 and the full BOS1921 data sheet is available here: [BOS1921 Development Kit](#)

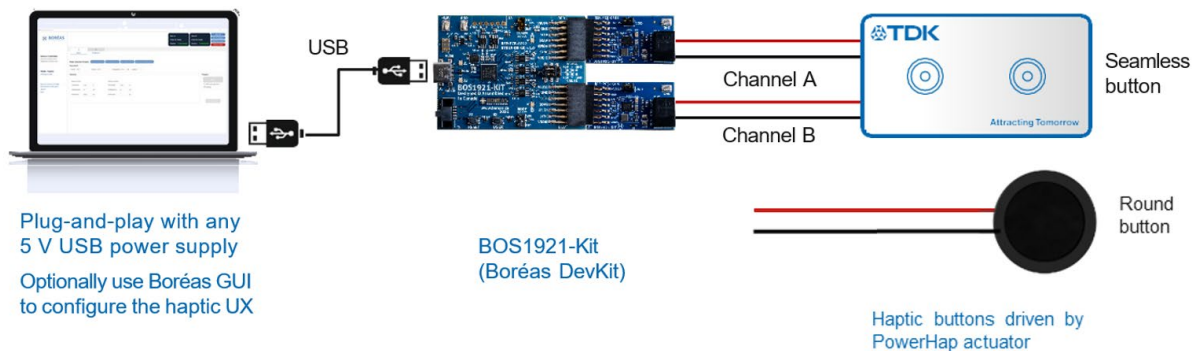

Figure 10: Connecting and using the PowerHap Starter Kit

The Boréas Development Kit features make it easy to customize and tailor the haptic experience by adjusting the sensing detection parameters and the haptic feedback waveform. The easiest way to customize the sensing and waveform parameters requires the installation of the Boréas Haptic Studio. Download the software here: [BOS1921 Development-Kit – Boréas Technologies \(boreas.ca\)](#)

One detailed, yet important note: the BOS1921 can provide a boosting voltage of  $\pm 95$  V, which is ideal for PowerHap 1204 that allows a boosting voltage of -10 up to +95 V. However, PowerHap 1313 can be used up to -20 ... +120 V and furthermore its larger capacitance (see table 1) limits a full operation of BOS1921, limiting the boosting capacity with PowerHap 1313 to about -20 up to +60 V. Hence, for a full utilization of PowerHap 1313's capacity other drivers could be considered, e.g. BOS1211 from Boréas.

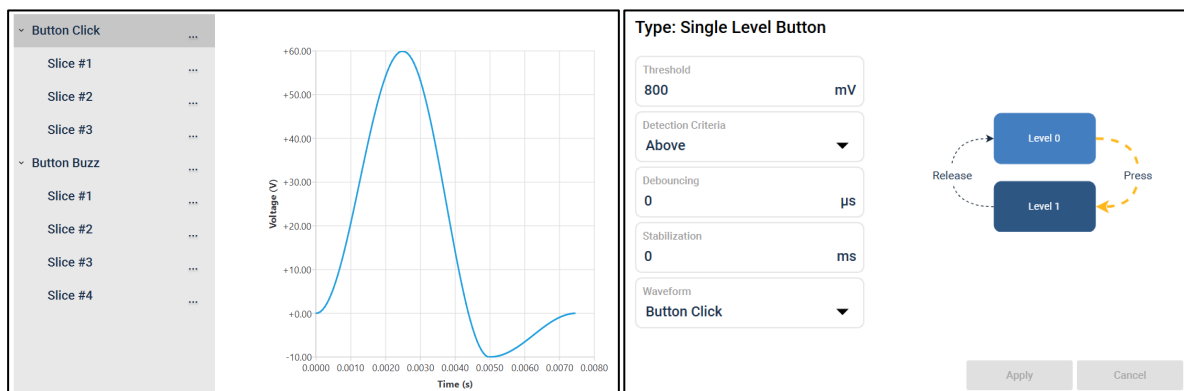

Figure 11: Boréas Haptic Studio Waveform and Button Editor when connected. The shown parameters are the default settings for channel A. Channel B has similar settings, except 15 cycles instead of 1 cycle and with -10 up to +60 V.



# PowerHap Starter Kit

## Design Guide

### HAPTIC MEASUREMENTS

The haptic performance of the button assemblies depends on various parameters, such as the PowerHap actuator used, the driving signal and mechanical properties, e.g. the overlay material. The table below summarizes a series of haptic measurements, which have been performed on the actual Starter Kit button assemblies. The following test procedure and test equipment were used:

- Laser equipment: Polytec GmbH, fiber-optic interferometer OFV-551 / 552
- Accelerometer: TE Connectivity, accelerometer model 832 / 832M1
- Displacement and acceleration measured by pressing the button with 2N
- Channel OUTA and OUTB are programmed with the default Starter Kit configurations

Button assembly	PowerHap actuator	Driving HW	Channel	Frequency [Hz]	Cycles	Specified boost voltage [V]	Measured boost voltage* [V]	Measured acceleration [g]	Measured displacement [µm]
<b>Round button</b> 	1204	BOS1921-Kit	OUTA	175	1	-10 ... +95	-10 ... +85	4.5	35
	1313	BOS1921-Kit	OUTA	175	1	-10 ... +95	0 ... +65	4.1	28.3
	1204	BOS1921-Kit	OUTB	175	15	-10 ... +60	-10 ... +60	4.3	28
	1313	BOS1921-Kit	OUTB	175	15	-10 ... +60	0 ... +55	4.1	27.4
	1313	BOS1211-Kit	-	175	5	0 ... +120	0 ... +120	4.8	45
<b>Seamless button</b> 	1204	BOS1921-Kit	OUTA	175	1	-10 ... +95	-10 ... +85	2.3	17
	1313	BOS1921-Kit	OUTA	175	1	-10 ... +95	0 ... +65	4	25
	1204	BOS1921-Kit	OUTB	175	15	-10 ... +60	-10 ... +60	1.5	11.6
	1313	BOS1921-Kit	OUTB	175	15	-10 ... +60	0 ... +55	1.9	18.2
	1313	BOS1211-Kit	-	175	5	0 ... +120	0 ... +120	3.9	29.2

\* Note that the BOS1921-Kit cannot utilize the full capabilities of the PowerHap 1313 actuator. Firstly, the 1313 actuator can be used at a voltage range of -20 to +120 and secondly its large capacitance limits the boosting voltage of the BOS1921-Kit, hence the measured boost voltage is lower (and distorted – if you look with an oscilloscope) than the specified boost voltage.

Table 15: Haptic performance measurements using the PowerHap Starter Kit

# PowerHap Starter Kit

## Design Guide

### APPENDICES AND APPLICATION NOTES

#### POWERHAP DATA SHEET

Please find all our latest PowerHap actuator data sheet on the TDK Electronics webpage here:

<https://www.tdk-electronics.tdk.com/en/powerhap>

#### DESIGN SUPPORT: APPLICATION NOTES AND DESIGN FILES

TDK is continuously working on extending its library of technical applications notes. Please contact us for the latest status. At present, the following PowerHap Starter Kit support material is available:

##### Starter Kit design files:

1. STEP file seamless button: Seamless\_Button\_Z01\_Ind.03
2. STEP file round button: Round\_Button\_Z01\_Ind.03
3. PowerHap 1204H018V060 FPC: StarterKit\_FPC\_Ind.00.zip / 6D-BVZ-PZ-1204-SK-FPC.pdf
4. PCB used to connect to PowerHap 1204H018V060 FPC: StarterKit\_PCB\_Ind.00.zip

##### Application notes:

1. PowerHap External Backstop
  - a. How to design an external force limiter into your PowerHap design

### CONTACT INFORMATION

For further information and support, please contact our team via the following email address:

[haptics@tdk.com](mailto:haptics@tdk.com)

### REVISION HISTORY

<b>Design Guide v1 (Dec 21)</b>	Original
<b>Design Guide v2 (Jul 22)</b>	New round button design in Figures 5, 6, 8 PowerHap 1313 picture update Final measurement data in Figure 4 and Table 15
<b>Design Guide v3 (May 23)</b>	Updated PowerHap 1313 design Updated STEP and Gerber files Ind.03 New design Figures 1, 2, 6, 9
<b>Design Guide v4 (Jan 24)</b>	Upgrade Boreas board from BOS1901 to BOS1921
<b>Design Guide v5 (Aug24)</b>	Updated Development Kit GUI in Figure 11



# PowerHap Starter Kit

## Design Guide

### CAUTIONS AND WARNINGS

This Starter Kit was developed to support customers during their first steps in designing applications with the PowerHap piezo actuators for haptic feedback. The design is not qualified for manufacturing nor operation over the whole operating temperature range or lifetime. The Starter Kit provided by TDK is intended to be used for functional testing only.

Due to their purpose, evaluation kits are not intended to be used for the same procedures regarding returned material analysis (RMA) and process change notification (PCN) as regular products.

	<b>Danger!</b> <b>High voltage!</b> Electric shocks are possible when connecting the board to live wire. The board should be handled with care by a professional. For safety, the use of isolated test equipment with overvoltage and/or overcurrent protection is highly recommended.
	This product uses semiconductors that can be damaged by electrostatic discharge (ESD). When handling, care must be taken so that the devices are not damaged. Damage due to inappropriate handling is not covered by the warranty.

- Do not open the protective conductive packaging until you have read the following and are at an approved anti-static workstation:
  - Use a conductive wrist strap attached to a good earth ground.
  - If working on a prototyping board, use a soldering iron or station that is marked as ESD-safe.
  - Always disconnect the microcontroller from the prototyping board when it is being worked on.
  - Always discharge yourself by touching a grounded bare metal surface or approved anti-static mat before picking up an ESD - sensitive electronic component.
  - Use an approved anti-static mat to cover your work surface.
- The piezo component must be operated in a dry, non-reducing, open environment and atmosphere which must not contain any chemical vapors or substances. To prevent damage to the piezo component, tensile stresses must be avoided under all driving conditions.
- We expressly point out that in case of non-observance of the aforementioned information, in particular due to reasons attributable to chemical vapors, a malfunction of the piezo sample or failure before the end of its usual service life cannot be completely ruled out, even if they are operated as specified.
- Depending on the individual application, piezo samples are electrically connected to voltages and currents, which are potentially dangerous for the life and health of the operator. Installation and operation of piezo samples must be carried out by authorized personnel only. Ensure proper and safe connections, couplers, and drivers.
- Piezo components are highly efficient charge storing capacitors. Even when they are disconnected from a supply, the electrical energy content of a loaded actuator can be high and is retained for a long time. Always ensure that the actuator is fully discharged (e.g., via a 10 kΩ resistor) before handling. (Do not discharge by simple short-circuiting, because of the risk of damaging the ceramic.)
- Electrical charges can be generated on disconnected actuators by varying load or temperature. Discharge an actuator before connecting it to a measuring device/electronics, when this device is not sufficiently voltage proofed.

### NOTE

- No warranty or liability shall arise for the supplier out of and in connection with these products. The use shall be at the sole risk of the purchaser. The supplied products are development samples and have prototype status only and may not be used in series products of the purchaser. Our products are subject to a continuous improvement process, which may lead to changes in product specifications. Therefore, we ask you to contact your sales channel or visit our TDK website to find out more about the current specification status of our products for your follow-up orders.
- Contains SVHC Substance 12626-81-2
- Trademarks: All trademarks are the property of their respective owners.

**Important information:** Some parts of this publication contain statements about the suitability of our products for certain areas of application. These statements are based on our knowledge of typical requirements that are often placed on our products. We expressly point out that these statements cannot be regarded as binding statements about the suitability of our products for a particular customer application. It is incumbent on the customer to check and decide whether a product is suitable for use in a particular application. This publication is only a brief product survey which may be changed from time to time. Our products are described in detail in our data sheets. The *Important notes* ([www.tdk-electronics.tdk.com/ImportantNotes](http://www.tdk-electronics.tdk.com/ImportantNotes)) and the product-specific Cautions and warnings must be observed. All relevant information is available through our sales offices.