

## Operating Instructions

# piezobrush PZ3

World's Smallest Plasma Handheld Device with PPD Technology  
by relyon plasma, a TDK Group Company

piezobrush® PZ3 generates highly efficient cold plasma for the optimization of adhesion processes like gluing, printing and bonding. Use it on a variety of materials e.g. plastics, metals, glass, semi-conductors, ceramics, natural materials.

### Modules

- The Module standard is used for non-conductive materials like plastics
- The Module nearfield is used for conductive materials like metals

### Key benefits

- Easy, safe and intuitive plug-and-play technology
- Integrated display for process control and power settings
- Works with air as ambient process gas

Ordering code  
B54324D5120A140



# piezo brush<sup>®</sup> PZ3

## Operating instructions for piezobrush<sup>®</sup> PZ3 handheld device



Thank you for purchasing a **relyon plasma GmbH** branded product. To get the best from your device, please read these instructions carefully.



### **Important!**

**Read these instructions carefully before assembling, installing and starting up the device!**

**Always follow the safety instructions!** Failure to follow the safety instructions may result in accidents, serious injury and serious damage to the device.

**Train your staff!** The operator / user is responsible for ensuring that personnel have fully understood the operation of the device and the safety requirements.

© Copyright **relyon plasma GmbH** 2020.

All rights reserved. All rights reserved.

Text, images and diagrams and their layout are protected by copyright and other laws. Unauthorised copying and distribution of this document and the utilisation and communication of its contents are strictly prohibited unless expressly authorised. Offenders will be held liable for the payment of damages. All rights reserved in the event of a patent, utility model or ornamental design registration are granted.

<b>1</b>	<b>Safety</b> .....	<b>4</b>
1.1	Residual risks.....	4
1.2	Information and obligations for the operator.....	6
1.3	Impermissible operating conditions.....	6
1.4	Emissions.....	6
<b>2</b>	<b>Description of device</b> .....	<b>7</b>
2.1	Intended use.....	7
2.2	Scope of delivery.....	7
2.3	Description of device.....	8
<b>3</b>	<b>Technical data</b> .....	<b>10</b>
<b>4</b>	<b>Transport / storage</b> .....	<b>10</b>
<b>5</b>	<b>Installation</b> .....	<b>10</b>
<b>6</b>	<b>Special note on the operation of the plasma process</b> .....	<b>11</b>
6.1	General description.....	11
6.2	Carrying out surface treatment.....	12
6.3	Measures to take after the surface treatment.....	12
<b>7</b>	<b>Operation</b> .....	<b>13</b>
7.1	Inserting / removing the module.....	13
7.2	Installation.....	14
7.3	User menu.....	16
7.4	Process tools.....	18
7.5	Working with module „Standard“.....	19
7.6	Working with module „Nearfield“.....	19
7.7	Working with other modules.....	19
<b>8</b>	<b>Taking out of service</b> .....	<b>20</b>
<b>9</b>	<b>Maintenance</b> .....	<b>20</b>
9.1	Cleaning.....	20
9.2	Replacing a module.....	20
<b>10</b>	<b>Troubleshooting</b> .....	<b>21</b>
<b>11</b>	<b>Environment</b> .....	<b>22</b>
11.1	Disposal.....	22
<b>12</b>	<b>Conformity / standards</b> .....	<b>22</b>
12.1	CE.....	22
12.2	Product standards.....	22
12.3	Licenses.....	22
<b>13</b>	<b>Spare parts</b> .....	<b>23</b>

# 1 Safety

This device is built according to corresponding international standards. Like with every technical product incorrect or not intended use can however be dangerous. Follow the instructions in this operating manual in addition to the general safety regulations.



## Caution - Danger!

When working with the device, please note and observe the safety instructions and requirements in these operating instructions because non-compliance may result in serious or fatal injury.

## 1.1 Residual risks

This device has been manufactured in accordance with the current state of the art. However, it is impossible to eliminate residual risks.

Always adhere to the following safety instructions:



### Caution – Electrical voltage!

Only use the external power plug provided.

Danger from mains voltage. If the external power plug is visibly damaged:

- Do not use the damaged part.
- Have the damaged parts repaired by a qualified person or replace them.

Danger from sparks on the piezo element and the substrate to be treated:

- Do not reach into the area of the plasma discharge
- Electrically conductive substrates must be grounded or protected against touching.



### Attention – Emissions!

Dangerous amounts of the reaction gas ozone ( $O_3$ ) may be produced during device operation.

- Volumes of ozone in excess of  $0.2 \text{ mg/m}^3$  may be produced.
- Note that national health and safety measures must be observed when operating the device.
- Only use the device in well vented areas or in conjunction with a suitable extraction device
- Do not leave the device running unattended.
- Do not point the device at people when in operation.



### **Attention – Damage to device!**

Under no circumstances may the fan cover on the rear side of the device be closed. This would interrupt the supply of cooling medium required in operation.

Never touch the piezo crystal at the front of the device with sharp-edged objects. This component may be damaged by improper handling.

Protect the plasma generator from falls or other hard impacts which may damage the electronics or piezo element.



### **Attention! Device for use in industrial environment**

Due to the presence of both conducted and radiated interference, this device may have difficulty in ensuring electromagnetic compatibility in other environments.



### **Caution – hot surface!**

The exchange modules can become hot during operation. Do not touch them until they have cooled down and take care not to damage thermally sensitive surfaces when working with the exchange modules.

The workpiece to be treated can also heat up during the plasma process, depending on the process parameters. If necessary, allow the workpiece to cool down before touching it.

## 1.2 Information and obligations for the operator

- The system may emit interference.
  - The system has been tested in accordance with EMC legislation.
  - The operator must verify and assure electromagnetic compatibility with other electrical and electronic equipment in the immediate vicinity of the system.
- Ensure that:
  - Operating personnel have read and understood these operating instructions.
  - Anyone working near the device is made aware of the dangers and is provided with the necessary protective equipment.
  - Repairs are only carried out by qualified persons.
- In particular, make operating personnel aware of the safety instructions in this document.
- Always keep the system in fully functional condition.
- Any modifications made to the device will invalidate the operating licence and the warranty. Exception: Such modifications are expressly authorised by the manufacturer.

## 1.3 Impermissible operating conditions

The device must not be operated under the following conditions:

- In explosive (Ex) zones
- In areas with severe build-up of dust
- In environments where the humidity is too high (see chapter 3 Technical data )
- At altitudes of more than 2.000 m above sea level
- Where there are strong vibrations

## 1.4 Emissions

The connected plasma generator produces the following emissions:

- Ozone (O<sub>3</sub>)  
Example:

Plasma gas	Gas flow	Ozone
Air	Ca. 8 l/min	< 0,12 g/h



### Note!

As a precautionary measure, we recommend an extraction system with about 100 m<sup>3</sup>/h in the direct vicinity of the plasma outlet.

## **2 Description of device**

### **2.1 Intended use**

The piezobrush® PZ3 is a handheld device for generating technical plasma. It is used to pre-treat a wide range of material surfaces before processes such as gluing or printing. It is also possible to use the cleaning effect of the plasma.

Only use the device for the intended purposes. Failure to do so may restrict product liability.

### **2.2 Scope of delivery**

The scope of delivery includes the following components:

- Plasma generator
- Module "Standard"
- Module "Nearfield"
- Plug-in power supply (cable length 1,5 m)
- Operating instructions



## 2.3 Description of device

The individual parts of the generator are shown and named in the diagram below. These terms are used throughout the operating instructions.

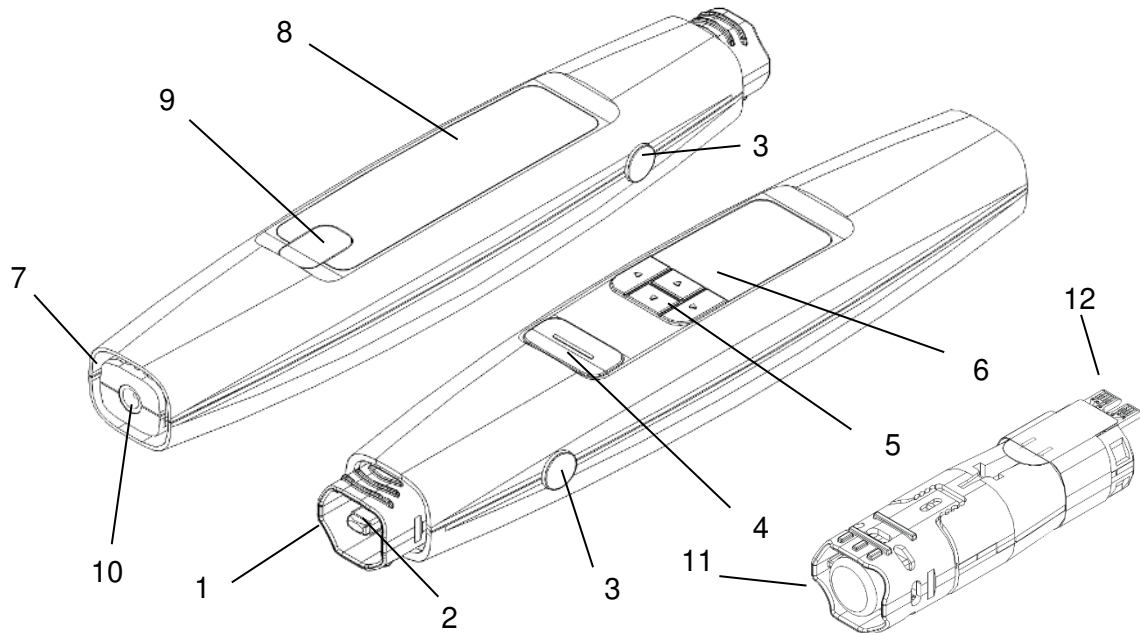

No.	Component description
1	Module „Standard“ (inserted)
2	Piezo element in module (embedded in module)
3	Module release button (on both sides)
4	Start/Stop button
5	Menu buttons
6	Display
7	Air inlet
8	Type plate
9	Service port cover (only for service by relyon plasma)
10	DC socket for plug-in power supply
11	Modul „Nearfield“ (entnommen dargestellt)
12	Contact board on module

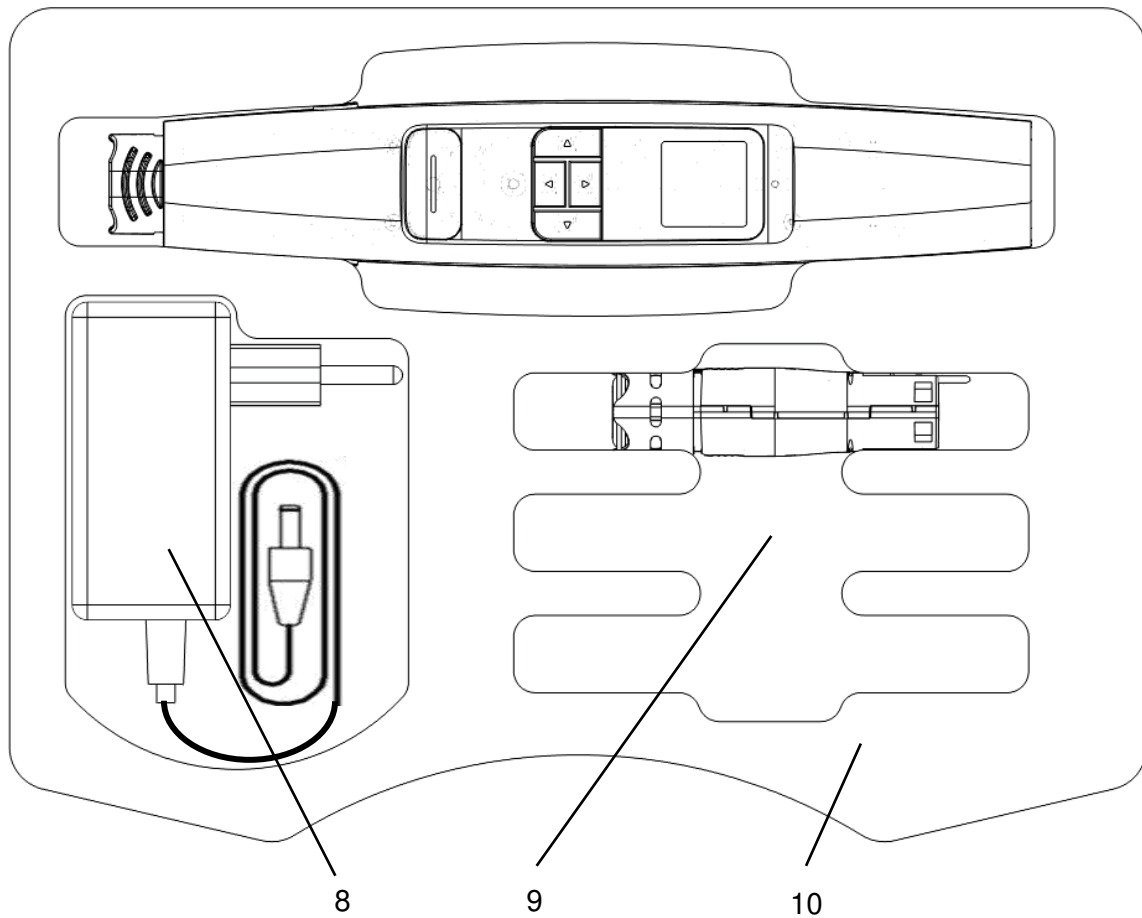

No.	Component description
8	Plug-in power supply
9	Compartments for optional modules
10	Foam insert



### Attention!

The piezo element is an oscillating component that vibrates mechanically at high frequency. Due to its design, this component cannot be fixed rigidly. For this reason, the component can lie off-center in the interchangeable modules within certain limits. This is not an error or quality defect.

Due to the vibration, audible frequencies may also occur under certain circumstances. This is also normal and not a fault or quality defect.

### 3 Technical data

Electrical data	
• Supply voltage	24 V DC (device) / 110 – 230 V AC (power supply)
• Power consumption	max. 18 W
• Model	Handheld device with plug-in power supply
Dimensions	
• Weight	110 g (not including plug-in power supply)
• Length	215 mm
• Diameter max.	38 mm
• Diameter min.	27 mm
• Cable length	1500 mm
Typical application parameters (exemplary for module „Standard“)	
• Plasma temperature	< 50 °C
• Treatment distance	2 – 10 mm
• Width of treatment	5 - 29 mm depending on process parameters (see chapter 6)
• Treatment speed	0 – 20 mm/s
Operating conditions	
• Air humidity	< 80 % rel. (non-condensing)
• Temperature	10 – 40 °C; 50 – 104 °F
Storage conditions	
• Air humidity	< 80% rel. (non-condensing)
• Temperature	0 – 60 °C; 32 – 140 °F

### 4 Transport / storage

- Store the plasma generator in a dry place. This will prevent corrosion of the electrical contacts. It is best to use the provided case for storage and transport.
- Protect the plasma generator from dirt and foreign bodies.
- Protect the plasma generator from falls or other hard impacts.

### 5 Installation

- Remove the plasma generator from the packaging.
- Use the external power plug to establish the power supply.
- Ensure that the workplace is well vented.



#### Attention - Damage to device!

In order to prevent damage to the device, please ensure that you follow the advice in chapter Fehler! Verweisquelle konnte nicht gefunden werden..

## 6 Special note on the operation of the plasma process

### 6.1 General description

Treating surfaces with atmospheric plasma has several advantages. These are e.g. the increase of the surface energy to produce a better wettability of the surface. An optimal surface wetting is the first and often decisive step to achieve excellent print quality, homogeneous coating, uniform varnishing or an integrally bonded application of adhesives. The bond at this interface often determines the durability and adhesive strength of this material pairing.

Atmospheric-pressure plasma increases throughput in many industrial processes, while at the same time saving costs for solvents or chemical primers. We have successfully integrated our plasma products into the following application fields:

- Cleaning of metal, glass and plastics
- Surface activation and surface functionalisation for optimised wettability
- Plasma-assisted laminating process
- Plasma-assisted adhesive bonded joints
- Plugging and sealing
- Plasma induced reduction of metal surfaces
- Chemical-free bleaching of textiles
- Plasma sterilisation of fabric
- Handling of food products for quality and shelf life
- Sterilisation of thermally-unstable plastics
- Air purification, odour and germ reduction
- Multi-component injection moulding

Practically all technical material classes can be efficiently processed under atmospheric pressure:

- Metals and metal alloys
- Plastics and composite materials
- Glass, ceramics, inorganic composites and natural stone
- Real leather and imitation leather
- Natural fibres, wood and paper

Since the plasma treatment is always just one part of the entire process, it is important to know the overall influences on the surface properties in order to achieve an optimal result.

Typical influencing factors are:

- Plasma process: Distance to the substrate, speed, nozzle geometry
- Substrate/ workpiece: Material composition, contamination, electrical conductivity, thermal conductivity, moisture content
- Workpiece treatment: Contamination before or after the plasma process, the time duration between the plasma process and the follow-up process

Treatment examples can be requested directly from **relyon plasma** GmbH.

Please note that the selected plasma system is suitable for the desired application. Additional information on applications, as well as publications, can be found on the website [www.relyon-plasma.com](http://www.relyon-plasma.com).

## 6.2 Carrying out surface treatment

Depending on the type and condition of your substrate, pre-cleaning before the plasma process can improve the overall outcome.

The effect of the treatment depends on the **working distance, treatment time, speed and consistency of movement as well as the material** to be treated.

Treatment examples can be requested directly from **relyon plasma** GmbH.

## 6.3 Measures to take after the surface treatment

To achieve an optimal result, it is important that as little time as possible elapses after the plasma treatment and that the treated surface is not touched or contaminated.

Cleaning the surface **AFTER** the plasma treatment is not recommended.

Since the workpiece can heat up depending on the type and duration of the plasma process, it may be necessary to allow the workpiece to cool down first before the next process step is executed in order to not negatively affect the follow-up process through the introduction of heat (e.g. certain bonding processes).



### Caution – Hot surface!

The workpiece to be treated can become heated up by the plasma process depending on the process parameters. If necessary, allow the workpiece to cool down before handling it.

## 7 Operation

### 7.1 Inserting / removing the module

The modules are provided with labels in different colours for easy identification. Please do not remove these labels.

To insert a module, take it out of the packaging and hold it in the area of the nozzle outlet without touching the piezo element (picture 1).

Please note that the contact board of the module must be on the same side as the display of the device to allow insertion.

Carefully insert the module into the device as shown in the picture without using force until the module locks into place.

When the device is switched on, the type of module detected is now shown in the display.

To remove a module, wait until it has cooled down. Depending on the type of module, operation can lead to a significant increase in temperature.

Hold the device in one hand, press both release buttons simultaneously and keep them pressed. With the other hand, hold the module in the area of the nozzle outlet without touching the piezo element and carefully pull the module out of the device (picture 2).

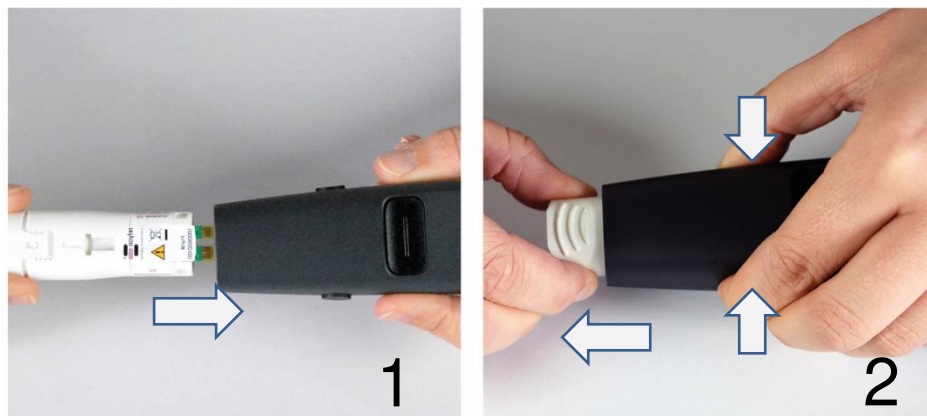

#### Caution – hot surface!

The exchange modules can become hot during operation. Do not touch them until they have cooled down and take care not to damage thermally sensitive surfaces when working with the exchange modules.



### Attention – Damage to device!

Do not reach into the interior of the unit if no module is inserted and do not insert any objects into the opening of the unit other than the modules provided for this purpose. Hold the modules only in the front area as described above and avoid touching the contact board and the piezo element. Insert and remove the modules carefully.

## 7.2 Installation

- Make sure that a module is inserted in the device.
- Make sure that the air inlet and nozzle outlet are not covered so that a sufficient flow of ambient air can be drawn in by the unit.
- Hold the unit only in the area of the button (picture 4), not in the area in front of it (picture 3).
- If the unit is to be mounted stationary, please observe the instructions below regarding electrically conductive objects (picture 5 to 8).
- Ensure that the ventilation / extraction of the working area is sufficient.
- Press the start/stop button to generate plasma



The device stops plasma activation after 5 minutes at the latest and goes into standby mode (in the case of special modules, plasma activation can stop after a shorter period of time).

You can return to the active mode by simply pressing the start/stop button and restart the activation by pressing the start/stop button again.



Do not reach into the work area during plasma generation. This can disturb the plasma discharge and can also cause skin irritation or be perceived as slightly painful.



### Attention - Damage to device!

The plasma generator can be damaged if it is operated without air supply. This would interrupt the supply of the cooling medium required during operation. Never cover the air inlet and/or the nozzle outlet during operation.

The plasma generator can be damaged if electrically conductive objects are closer than 60 mm to the front third of the plasma generator during operation.

**Exception:** Substrates in front of the module when using modules designed for this purpose.



### Note!

Under certain circumstances, the electric fields generated by the plasma generator can damage sensitive electronic components. Make sure that the components of your application are not affected by the plasma process.



## 7.3 User menu

The device starts in the menu item "Home".



The home menu provides you with an overview of various pieces of information while you work with the device.

To navigate through the menu items, use the "<" (left) and ">" (right) buttons on the keypad. To change the settings in the menu items, use the buttons "^" (up) and "v" (down). In the menu items 3 to 8 you can return to the menu item "Home" by pressing the start/stop button.

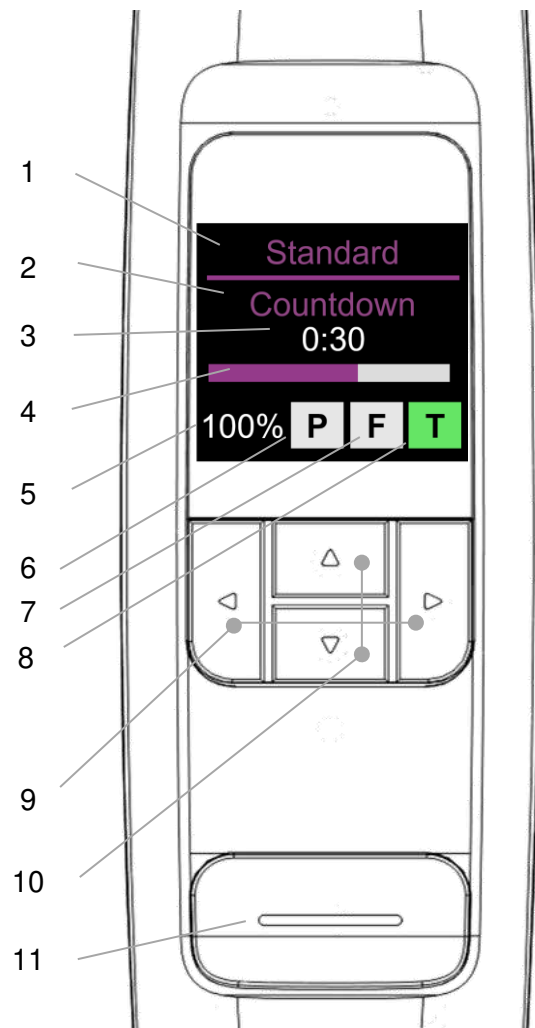
Please note that the direction of the arrow keys also changes accordingly when the display orientation is changed.

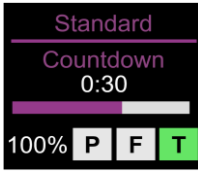

Nr.	Description	Function
1	Module type	Displays currently inserted module
2	Process tool mode	Displays selected process tool
3	Time value	Zeigt aktuellen Zeitwert an
4	Time bar	Graphical representation of the time lapse
5	Power setting	Displays currently selected power value
6	Status plasma	Grey: not active Green: OK Yellow: critical Red: Error
7	Status fan	Grey: not active Green: OK Yellow: critical Red: Error
8	Status temperature	Grey: not active Green: OK Yellow: critical Red: Error
9	Arrow keys left / right	Navigation through menu items
10	Arrow keys up / down	Setting within the menu items
11	Start/Stop button	Starts and stops plasma treatment; return to "Home"; confirm errors

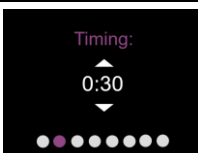
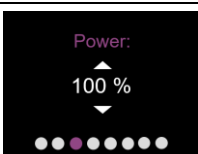
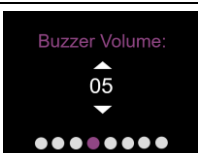
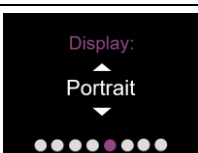
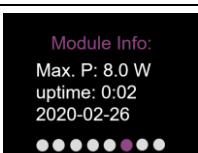
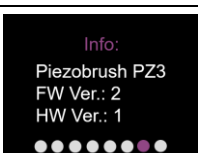
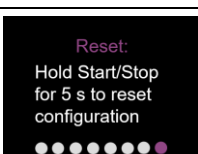
#	Menu item/description	Settings	Display
1	Start: Device is booting and switches to the menu item "Home" when ready	-	
2	Home: Overview; pressing the start/stop button starts or stops the plasma activation	-	
3	Process: Selection of the various process tools	- Stopwatch - Countdown - Metronome	
4	Timing: Setting the duration for the selected process tool	1s to 300s in increments of 1s	
5	Power: Setting the plasma power	50% to 100% in increments of 10%	
6	Buzzer Volume: Setting the volume of the acoustic feedback	0 to 5 in increments of 1	
7	Display: Setting the display orientation	3 different orientations selectable	
8	Module Info: Information about the currently inserted module	-	
9	Info: Information about the hardware and software version of the device	-	
10	Reset: By holding the start/stop button for 5 seconds, all device settings are reset to the factory settings	-	

## 7.4 Process tools

As described in section 7.3, the device provides various functions as tools to support the plasma treatment process.

- **Stopwatch**

The device measures the duration of plasma generation in 1 second steps from start to stop triggered by pressing of the start/stop button. The value measured last remains in the home menu until the next plasma generation is started.

This function can be used, for example, as an aid in process development to record the different treatment times of different samples.

The adjustability in the menu item "Timing" is deactivated in this mode (display "not applicable").

- **Countdown**

In countdown mode, a duration of plasma generation can be pre-set via the menu item "Timing". The unit is started using the start/stop button but stops activation automatically after the set duration has elapsed. The plasma generation can be stopped by pressing the start/stop button.

This function can be used, for example, if many samples are to be treated with plasma for the same amount of time.

- **Metronome**

In this mode the plasma generation is not deactivated after the time has elapsed, as it is in the "countdown" mode, but rather a regular acoustic signal is emitted.

This function can be used, for example, when large substrates are treated in lines and each line should have approximately the same duration.

## 7.5 Working with module „Standard“

This module is used for various applications on non-electrically conductive substrates / materials such as plastics, ceramics, glass, natural fibres, leather, textiles etc. The range of the permissible working distance is approx. 2 to 10 mm.

Electrically conductive substrates such as metals or conductive polymers cannot be reliably treated with this nozzle.

When treating electrically conductive substrates / materials, arcing can occur if the distance is too small. In this case the unit will stop plasma generation after approx. 0,5 seconds.

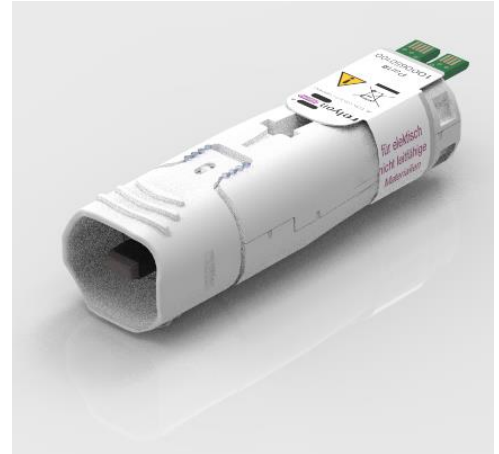

## 7.6 Working with module „Nearfield“

The module "Nearfield" was especially designed for the treatment of electrically conductive substrates / materials such as metals or conductive polymers. Even partially conductive materials such as carbon fiber reinforced plastics (CFRP) should be treated with this module.

The device can only generate a surface activation if an electrically conductive substrate is in front of the device within the range of the permissible working distance. This is approx. 0.5 to 2.0 mm. If the distance is greater, plasma generation may not be possible under certain circumstances, depending on the material and geometry of your substrate.

If too great a distance is selected, the unit automatically stops plasma generation after 5 seconds.



### Caution - hot surface!

The module can become hot during operation. Do not touch the module immediately after operation. Do not touch the substrate with the module during operation.

## 7.7 Working with other modules

It is planned to develop further modules for this device. Please refer to the corresponding operating instructions enclosed with these modules.

## 8 Taking out of service

- Press the start/stop button again to stop plasma generation.
- Disconnect the power supply once work is completed.

## 9 Maintenance

### 9.1 Cleaning

- Clean the plasma generator only on the outside.
- Make sure that the plasma generator is disconnected from the power supply.
- Clean the plasma generator only with a cloth moistened with water. Do not use solvents to clean the plasma generator!
- Do not clean the piezo element.

### 9.2 Replacing a module

The modules can be subject to wear depending on the application and should be exchanged for consistent treatment results. Proceed as described in section 7.1.

You can obtain replacement modules directly from relyon plasma. To optimize our modules, we evaluate returned modules. Please contact us and send us back your defective or replaced modules for analysis.



#### **Attention – Damage to device!**

Never touch the piezo element at the front end of the device with sharp objects. This component can be damaged by improper handling.

## 10 Troubleshooting

Fault / error	Cause	Rectification
Device cannot be started or plasma extinguishes during operation.	Mains failure.	Check electrical power supply.
	Mains fuse triggered.	Check mains fuse.
	Mains plug not making contact correctly.	Check seat of mains plug.
	Mains plug is defective.	Replace mains plug.
	There is an internal error.	De-energise device. Switch on again.
	Piezo crystal broken, the plasma generator is defective.	Contact customer service.
	Shutdown due to overheating.	Allow the plasma generator to cool down. Ensure that the fan grille is not covered so that enough ambient air can be drawn in.
Plasma extinguishes during operation and device emits several short acoustic signals Indication on the display: „Plasma-failure“	Device does not find a permissible operating frequency.	Piezo element broken. Remove the defective module and insert a new one.
	Arcing on conductive substrate with e.g. "Standard" module.	Use a module suitable for the substrate, e.g. module "Nearfield".
	No conductive substrate in sufficient proximity to e.g. module "Nearfield".	Reduce the distance to the substrate or use a module suitable for the substrate, e.g. module "Standard"
As explained above, indication on the display: "Fan-failure"	Fan is defective.	Contact customer service.
As explained above, indication on the display: "overheated"	The device reached a impermissible inner temperature.	Allow the device to cool down. Check whether the air inlet and the nozzle outlet are not covered.
Error message in display: „No module inserted“	Module was not detected.	Check whether the module is inserted deep enough in the device. If necessary, remove the module and reinsert it. If necessary, insert a new module.
Error message in display: „invalid module inserted“	The module used is not compatible with the device.	Please contact customer service.

Should these actions not remedy the problem, please contact relyon plasma GmbH.

## 11 Environment

### 11.1 Disposal



#### Consider the environment.

Used electrical and electronic equipment must not be disposed of as household waste.

- The device contains valuable materials that can be recycled. Take the device to a suitable collection point.
- Please return defective or replaced modules to relyon plasma for analysis. Please contact us in advance.

## 12 Conformity / standards

### 12.1 CE



#### We declare that this product conforms to CE standards.

The product name can be found on the device's nameplate

### 12.2 Product standards

For the series-prdouction status we declare:

The device satisfies the following requirements and standards:

EMC	EN 55011:2018 + A1:2017 Group 2 Class A
	EN 61000-6-2:2019
	EN 61000-3-2:2019
	EN 61000-3-3:2014
LVD	EN 61010-1:2011
RoHS	EN 50581:2013-02
Protection grade IP20	EN 60529:2014-09

Note to our beta-testers:

Thank you very much for your support to improve this product. The delivered pre-series-version has slight deviations from EMC requirements. We will check, assess and -if possible- implement your feedback into the series-production status. Due to this, the series-production status device might have some deviations from the pre-series-version. As we are also very interested in how detailed our customers read the operating instructions, we ask you to add the note "I did find the beta-tester note in the operating instructions" to the online feedback form. Thank you very much.

### 12.3 Licenses

HMI font:

Droid Sans, Ascender Corp., Apache License

## 13 Spare parts

Order number	Description
1000650100	Module „Standard“
1000650200	Module „Nearfield“
1000640700	Plug-in power supply 24 V DC, 18 W (EU)
1000641200	Country adapter set for plug-in power supply (US, UK, AUS)

**relyon plasma GmbH**  
**A TDK Group Company**

Osterhofener Straße 6  
93055 Regensburg  
Germany

Telefon: +49-941-60098-0  
Fax: +49-941-60098-100  
E-Mail: [info@relyon-plasma.com](mailto:info@relyon-plasma.com)  
<http://www.relyon-plasma.com>





**Important information:** Some parts of this publication contain statements about the suitability of our products for certain areas of application. These statements are based on our knowledge of typical requirements that are often placed on our products. We expressly point out that these statements cannot be regarded as binding statements about the suitability of our products for a particular customer application. It is incumbent on the customer to check and decide whether a product is suitable for use in a particular application. This publication is only a brief product survey which may be changed from time to time. Our products are described in detail in our data sheets. The *Important notes* ([www.tdk-electronics.tdk.com/ImportantNotes](http://www.tdk-electronics.tdk.com/ImportantNotes)) and the product-specific *Cautions and warnings* must be observed. All relevant information is available through our sales offices.