

NTC Inrush Current Limiters

Application notes

Date: November 2015

© EPCOS AG 2015. Reproduction, publication and dissemination of this publication, enclosures hereto and the information contained therein without EPCOS' prior express consent is prohibited.

EPCOS AG is a TDK Group Company.

Application notes

1 Applications utilizing the non-linear voltage/current characteristic (in self-heated mode)

1.1 Inrush current limiting

Many items of equipment like switch-mode power supplies, electric motors or transformers exhibit excessive inrush currents when they are turned on, meaning that other components may be damaged or fuses may be tripped. With NTC thermistors it is possible to effectively limit these currents, at attractive cost, by connecting a thermistor in series with the load.

The NTC thermistors specially developed for this application limit the current at turn-on by their relatively high cold resistance. As a result of the current load the thermistor heats up and reduces its resistance by a factor of 10 to 50; the power it draws reduces accordingly.

NTC thermistors are able to effectively handle higher inrush currents than fixed resistors with the same power consumption.

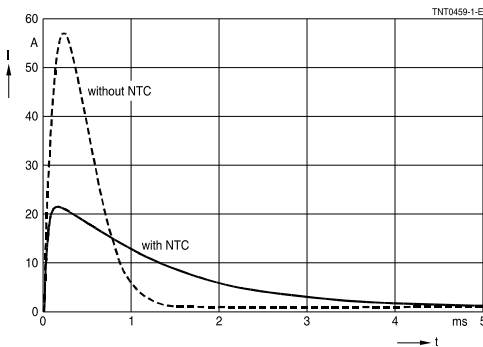

Figure 1
Inrush current curves in a simple DC circuit

The NTC thermistor thus provides protection from undesirably high inrush currents, while its resistance remains negligibly low during continuous operation.

1.2 Series and parallel connection

An NTC thermistor is always connected in series with the load to be protected. If the inrush current cannot be handled by one thermistor alone, two or more thermistor elements can be connected in series.

Paralleling several NTC thermistors is inadmissible, since the load will not be evenly distributed. The thermistor carrying the largest portion of current will heat up until it finally receives the entire current (which may result in destruction of the device), while the other paralleled thermistors remain cold.

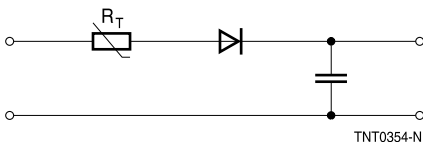

Figure 2
Basic circuit diagram for diode protection

Application notes

Figure 3 shows a typical example of an inrush protection circuit:

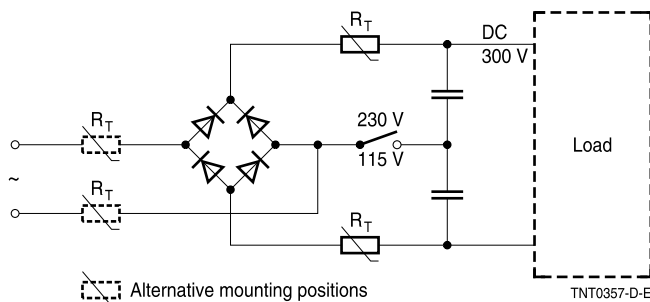

Figure 3
Mounting positions for NTC thermistors in a protective circuit

Selection of the most appropriate NTC thermistor is the precondition for effective circuit protection. The first and most important criterion is the maximum current during continuous operation, which is determined by the load.

1.3 Self-heating

The self-heating of an inrush current limiter during operation depends on the load applied. Although some heat is being dissipated, the NTC thermistor may in extreme cases reach a mean temperature of up to 250 °C. The dissipation factor δ_m , specified in the data sheets has been measured in still air at $T_A = 25$ °C on devices with clamp contacts. A change in the measuring conditions (e.g. stirred air = blower increases the dissipation factor) will influence the dissipation factor.

The heat developed during operation will also be dissipated through the lead wires. When mounting NTC thermistors it should therefore be considered that the contact areas may become quite hot at maximum load.

1.4 Load derating

The power handling capability of an NTC thermistor cannot be fully utilized over the entire temperature range. For circuit dimensioning the derating curve given below provides information on the extent to which the current must be reduced at a certain ambient temperature (T_A).

Derating curve for types S237, P11, P13 and P27

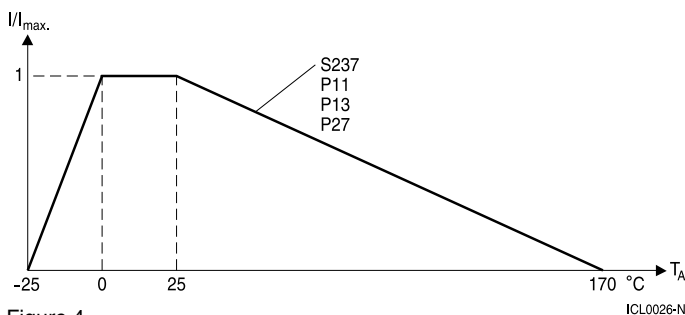

Figure 4

$$\text{Percent of } I_{\max} = 100 \left[1 - \frac{T_A - 25^{\circ}\text{C}}{T_{\max} - 25^{\circ}\text{C}} \right]$$

T_A = Ambient temperature > 25 $^{\circ}\text{C}$

T_{\max} = 170 $^{\circ}\text{C}$

Derating curve for types S153, S235, S236, S238, S364 and S464

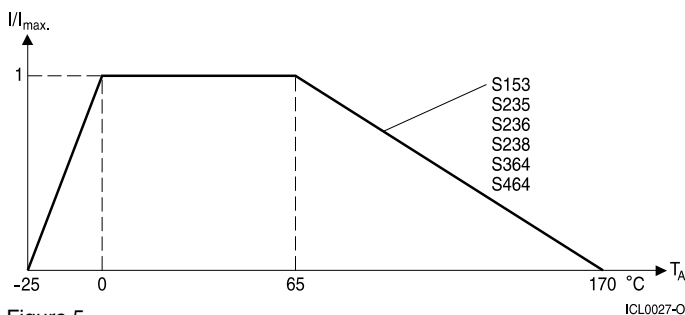

Figure 5

$$\text{Percent of } I_{\max} = 100 \left[1 - \frac{T_A - 65^{\circ}\text{C}}{T_{\max} - 65^{\circ}\text{C}} \right]$$

T_A = Ambient temperature > 65 $^{\circ}\text{C}$

T_{\max} = 170 $^{\circ}\text{C}$

Application notes

The I_{\max} values specified in the data sheets denote the maximum permissible continuous current (DC or RMS values for sine-shaped AC) in the temperature range 0 °C to 65 °C.

1.5 Restart

When the load has been switched off the thermistor slowly cools down. Its resistance increases steadily, but the full resistance value is only reached after 1 to 2 minutes (depending on ICL type).

It may therefore be useful in some applications to bypass the thermistor after restart. Operation can thus be faster resumed and system performance will not be affected by the thermistor.

1.6 Maximum permissible capacitance

The currents during turn-on are much higher than the rated currents during continuous operation. To test the effects of these current surges EPCOS uses the following standard procedure according to IEC 60539-1:

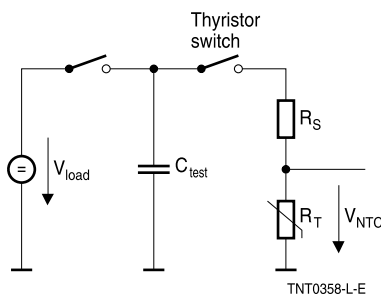

Figure 6

Test circuit for evaluating the maximum permissible capacitance of an NTC thermistor

V_{load}	Load voltage [V]
C_{test}	Test capacitance [μF]
R_S	Series resistance [$R_S = 1 \Omega$]
V_{NTC}	Voltage drop across the NTC under test [V]

The capacitor C_{test} is discharged via the series resistor R_S and the NTC inrush current limiter. The load voltage is chosen such that the voltage applied to the thermistor at the start of discharge is $V_{\text{NTC}} = 375 \text{ V}$ (corresponds to $(230 \text{ V} + \Delta V) \cdot \sqrt{2}$).

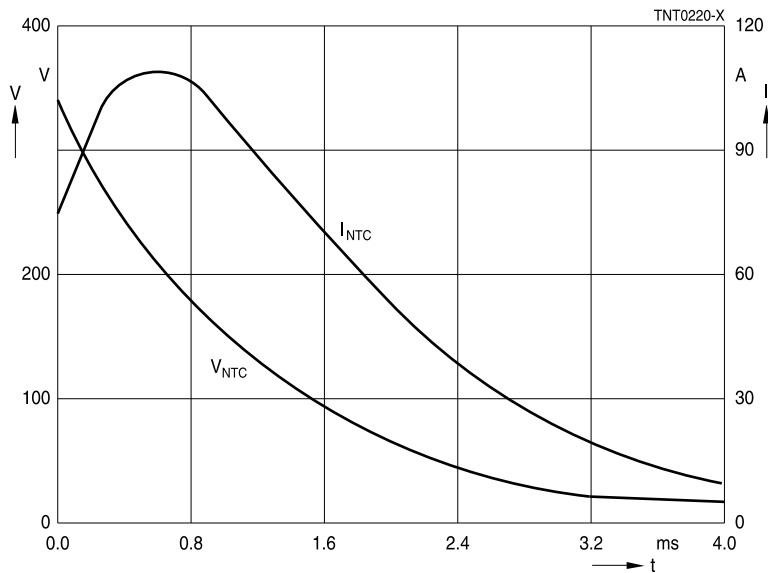

Figure 7
Maximum permissible capacitance discharging test: typical curves

The maximum capacitances that can be switched depend on the individual thermistor type and are given in the data sheets.

1.7 Notes on scaling an inrush current limiter

A few items of data are needed to scale an inrush current limiter:

- Load capacitance of device to be protected (determination of minimum size of the component)
- Steady-state current (I_{max}) and maximum ambient temperature
- Required reduction of inrush current to determine R_{25} of NTC inrush current limiters

Load capacitance of device to be protected

The high inrush current of devices results from the higher energy required to turn on. In power supplies the energy requirement is primarily caused by load capacitors, in transformers by magnetizing energy. The associated turn-on operations load the inrush current limiter as a current pulse. So this energy must be known to select the right component. It can be converted into capacitance for a given voltage. A suitable ICL will have a maximum permissible capacitance (C_{test}) that is higher than the capacitance in the application.

Application notes

Our C_{test} figures refer to line voltages of 110 V and 230 V. If an inrush current limiter is operated at other voltages (e.g. the low voltages of electronic circuits), the appropriate C_{test} figure is easily calculated:

$$E = \frac{CV^2}{2}$$

The required C_{test} determines the minimum size of the component.

Steady-state current and maximum ambient temperature

Select the component so that the steady-state current does not exceed the maximum admissible current (I_{max}) of the inrush current limiter. The maximum admissible current is produced from the figure for I_{max} and the derating in 2.4 with the maximum ambient temperature. When scaling a design, remember the possibility of line voltage fluctuations and different operating states (steady-state currents) of the device itself, and incorporate appropriate precautionary measures.

Required reduction of inrush current

The required C_{test} figure alone will determine the component that is needed. Within this component model the maximum steady-state current then determines the highest possible cold resistance (R_{25}) that can be used for an application.

The higher the cold resistance (R_{25}) of the inrush current limiter, the more the inrush current is dampened. If the current limiting effect of a component is inadequate, choose a larger model.

1.8 Application examples

Inrush current limiters are primarily used in industrial electronics and equipment engineering. Application examples are:

Inrush current limiting in fluorescent, projector and halogen lamps, rotational speed limiting in kitchen machines, soft start of motors and switch-mode power supplies etc.

EPCOS thermistors are available in a variety of sizes and rated resistances to optimally match your application. The product line ranges from the small-size S153 with a maximum power of 1.4 W through to the at present largest S464 with a maximum power of 6.7 W. Maximum continuous AC currents of 20 A are reached.