



## **PowerHap – Piezo Haptic Actuators**

PowerHap 1919 – with FPC connectivity

**Series/Type:** 1919H022V120  
**Ordering code:** B54104H1031A001  
**Date:** 2024-10-29  
**Version:** 2

## Features

- Large displacement
- High acceleration
- Fast response
- Force sensing capabilities

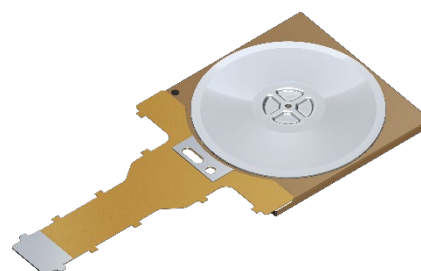

## Design

- Dimension of actuator: 19.3 x 19.3 x 2.2 mm
- Module dimension including FPC: 42 x 19.3 x 2.2 mm
- Contacting: Polarized piezo element, the positive and the negative terminals are marked (see Fig. 1)
- Contains RoHS-compatible PZT (lead zirconium titanate) ceramic (SVHC substance 12626-81-2)

## Applications

Vibrotactile haptic feedback for automotive applications such as buttons, modules, and medium-sized surfaces.

## General technical data

Parameter	Ratings
Operating voltage range	0 ... 120 V
Operating temperature powered	-40 ... +85 °C
Operating temperature unpowered	-40 ... +125 °C
Maximum compressive force on the actuator (during operation)	20 N (force applied evenly over the complete surface of the flat area of the cymbals)
Recommended minimum compressive force on the actuator within final assembly	3 N
Maximum impact force on the actuator perpendicular to cymbal contact surfaces (short-term)	400 N
Maximum pull force on FPC during handling (force parallel to FPC long-axis)	10 N
Maximum operation frequency	The operation frequency is limited by the self-heating of the component, which should not exceed +Δ5 °C. This is reached after about 3 s of continuous sine signal 0 to 120 V at 500 Hz.
Maximum voltage change rate	1.2 MV/s
Weight of component	approx. 3.5 g

**Electromechanical characteristics at 25 °C**

Parameter		Conditions	Typical
Capacitance	C	1 kHz, 1 V <sub>RMS</sub>	2.5 ±0.5 μF
Displacement	s	0 ... 120 V, measured at cymbal endcaps without preload	> 110 μm

**Further typical characteristics as a design reference for haptic applications at 25 °C**

Parameter		Conditions	Typical
1 <sup>st</sup> resonance frequency	f <sub>R</sub>	0.5 V <sub>RMS</sub>	13 kHz
Stiffness	k	120 V various load stiffness; preload 10 N	160 N/mm
Blocking force	F <sub>b</sub>	120 V various load stiffness (see Fig. 3 and 4)	19 N
Acceleration unipolar <sup>1)</sup> (see Fig. 6.)	a	Load mass 100 g, single pulse sine wave, 200 Hz, 0 ... 120 V	35 · g (peak to peak) 18 · g (peak)
		Load mass 200 g, single pulse sine wave, 200 Hz, 0 ... 120 V	25 · g (peak to peak) 11 · g (peak)
		Load mass 500 g, single pulse sine wave, 200 Hz, 0 ... 120 V	9 · g (peak to peak) 3 · g (peak)

<sup>1)</sup> g is the unit of acceleration, g = 9.81 m/s<sup>2</sup>

**Ordering code**

B54104H1031A001

**Dimensional drawings in mm**

Fig. 1: Dimensional drawings of PowerHap 1919 with FPC

**FPC details:**

- Material: polyimide flex
- Flex thickness: 0.1 mm
- Total thickness (flex and stiffener): 0.3 mm
- Cu finish: immersion gold 1U"
- Connector PN: Molex 2005280041
- Contacting: The polarized component needs to be properly connected to the driver. Connect the positive pin of the PowerHap to the high voltage output of the piezo driver.

Typical characteristics as a design reference for haptic applications

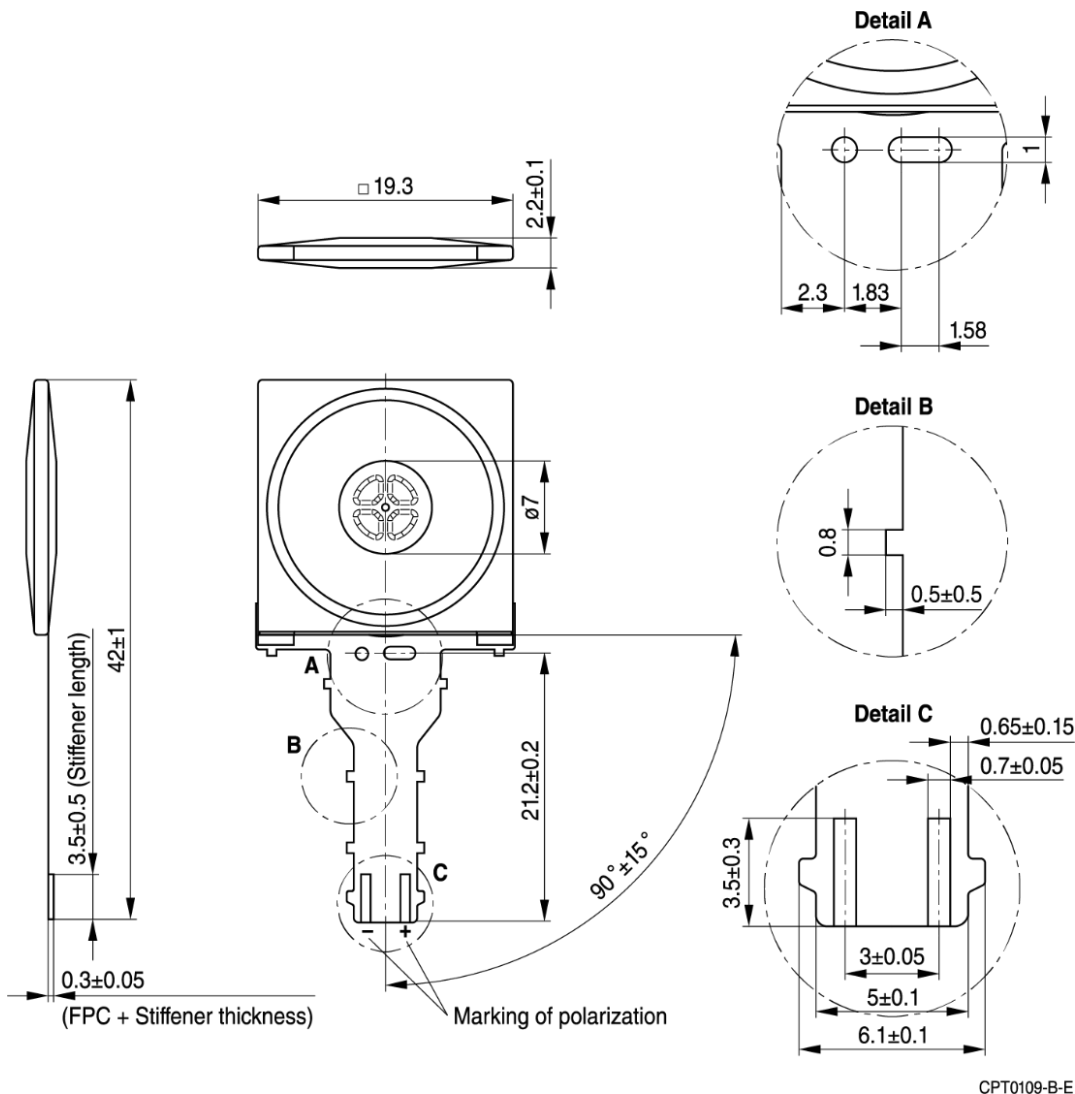
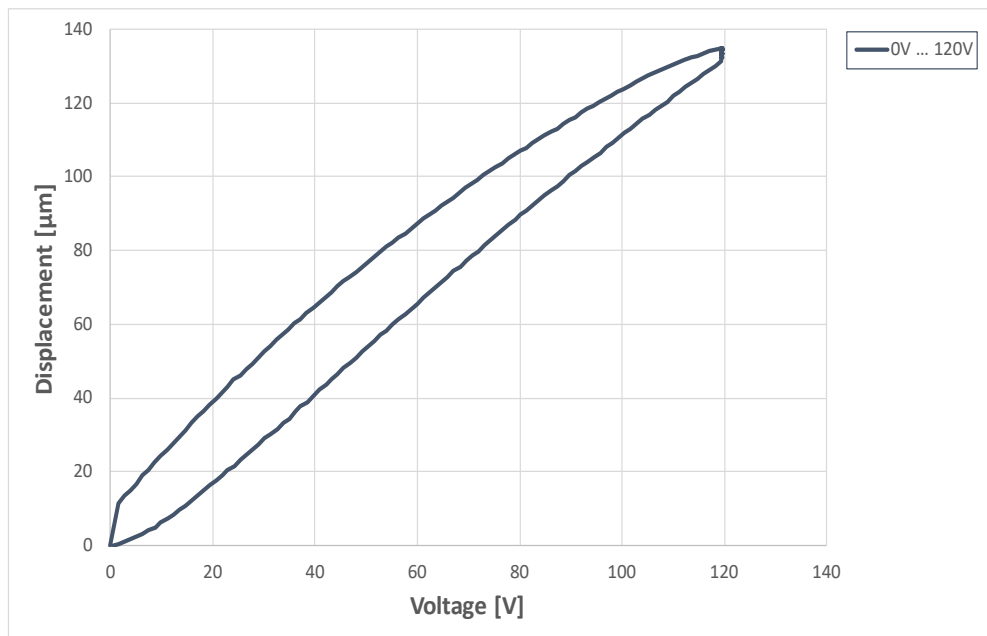

Fig. 2: Typical measurement of quasi-static displacement without preload measured at the cymbal endcaps as a function of voltage

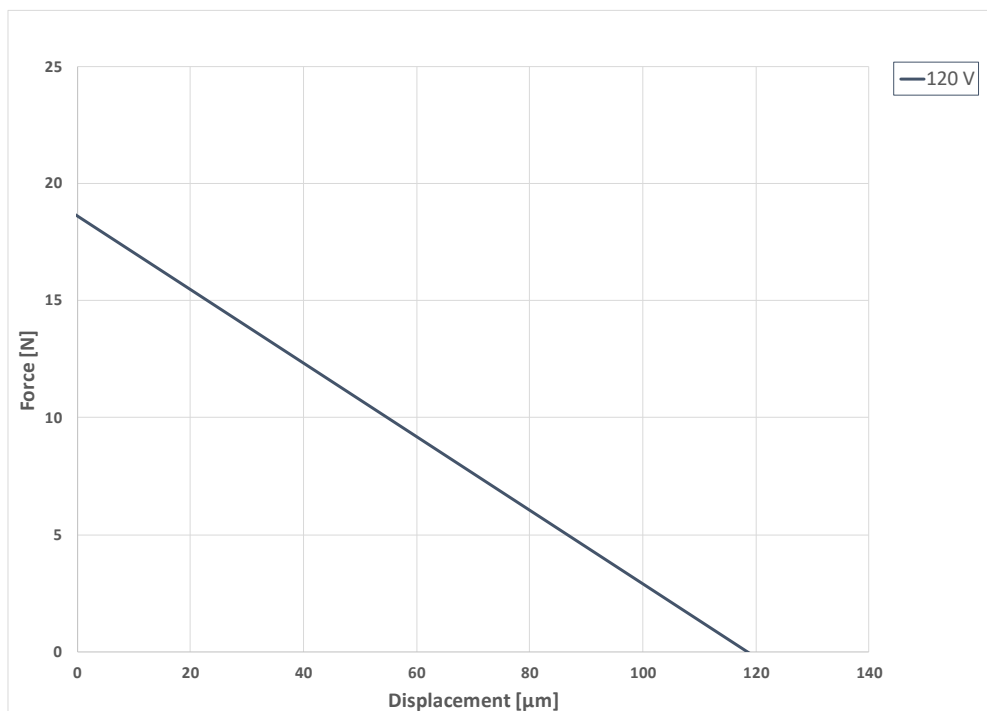

Fig. 3: Typical force-displacement diagram for preload 10 N

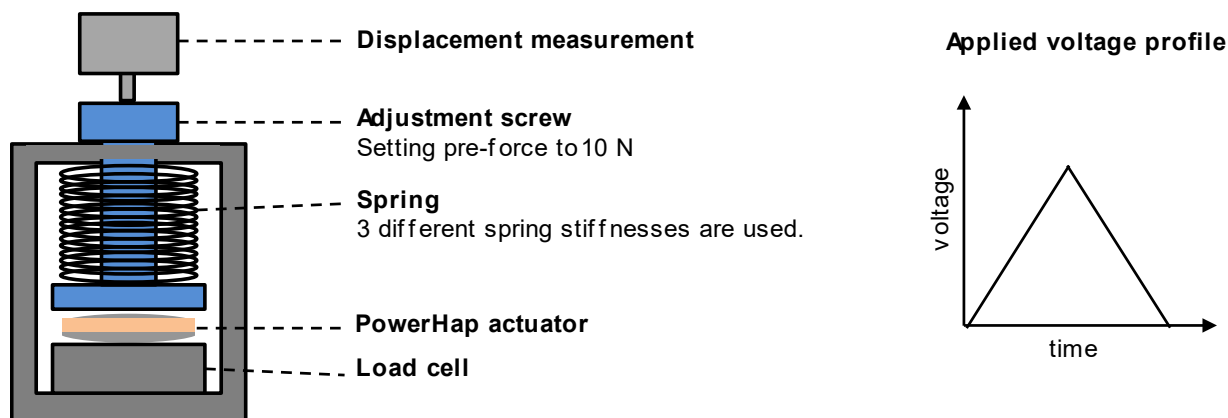

Fig. 4: The measurement setup for the force-displacement graph in Fig. 3.

In the force-displacement measurements, the PowerHap actuator is put under a dedicated pre-force of 10 N. The displacement and load are measured, while a voltage profile is applied (see Fig. 4) with  $V_{max}$  equal to 120 V.

### Acceleration characteristics

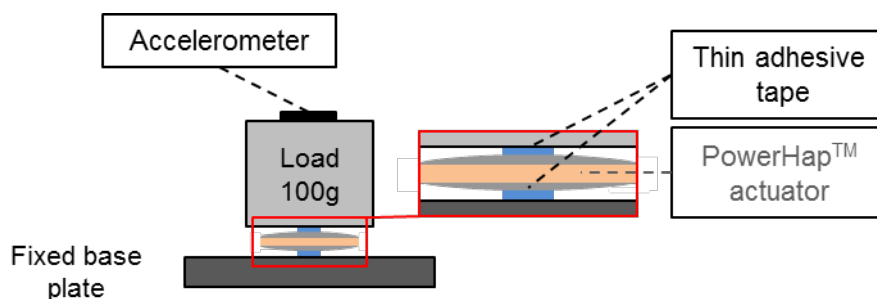

Fig. 5: Measurement setup for acceleration.

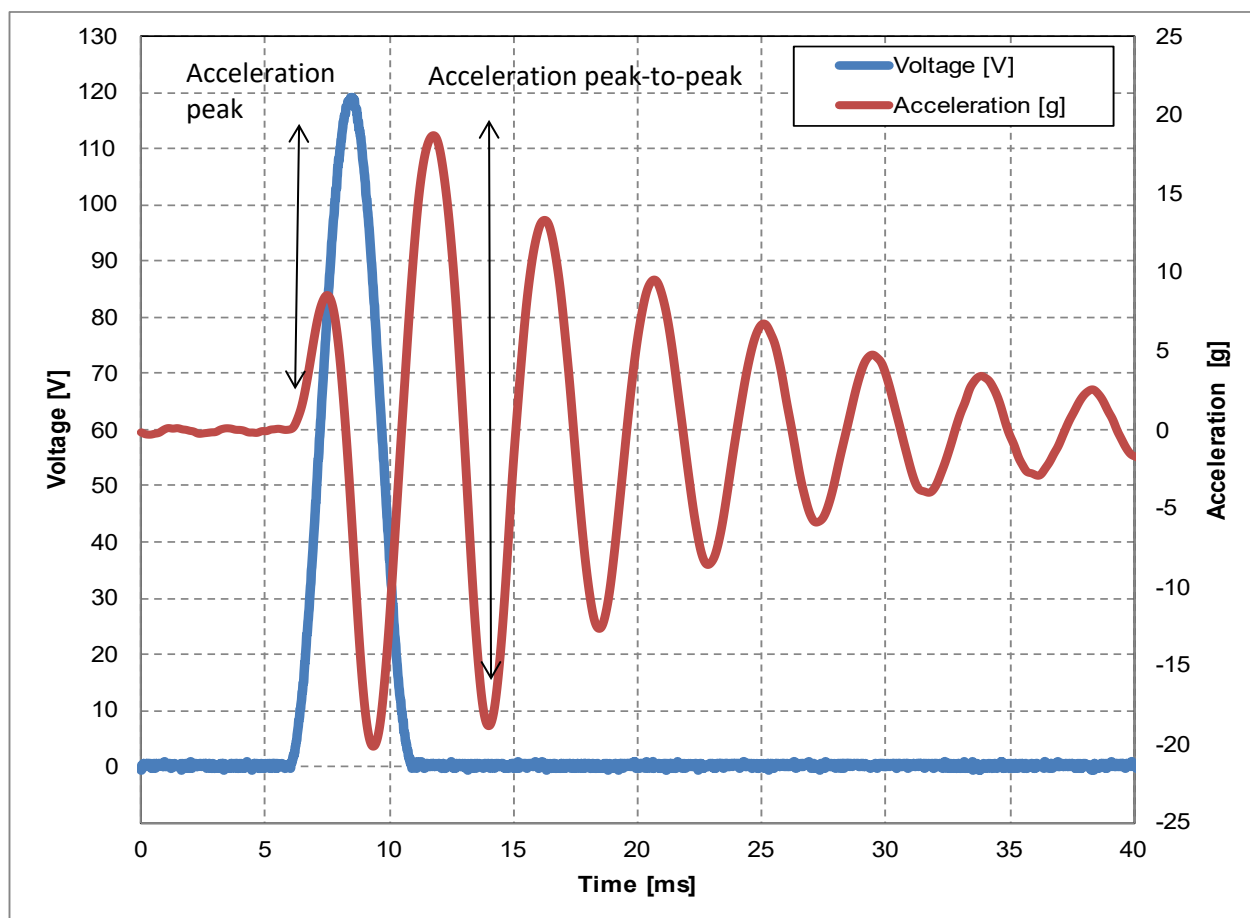

Fig. 6: Typical acceleration as a function of the input voltage with 100 g load. Input voltage with a half wave sinus signal form of amplitude 0 to 120 V and pulse length 5 ms which is equivalent to 200 Hz.

**Sensor characteristics**

By applying a compressive force to the center parts of the cymbal, an electric signal is generated.

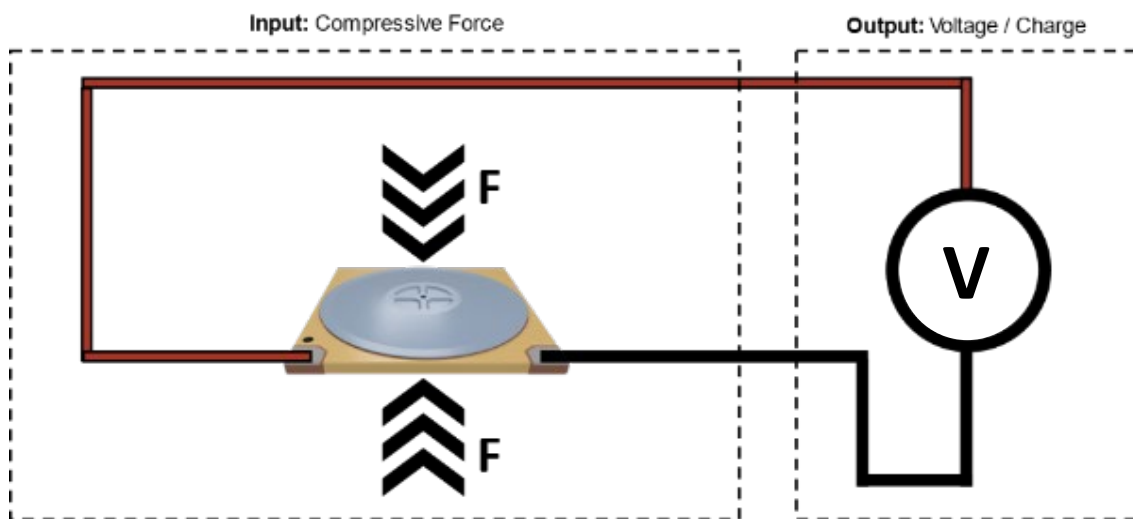

Fig. 7: Principle of measurement of the sensor signal

For a measurement circuit with very high impedance, i.e. near the open circuit limit, this can be measured as voltage. The typical voltage per force is 0.26 V/N.

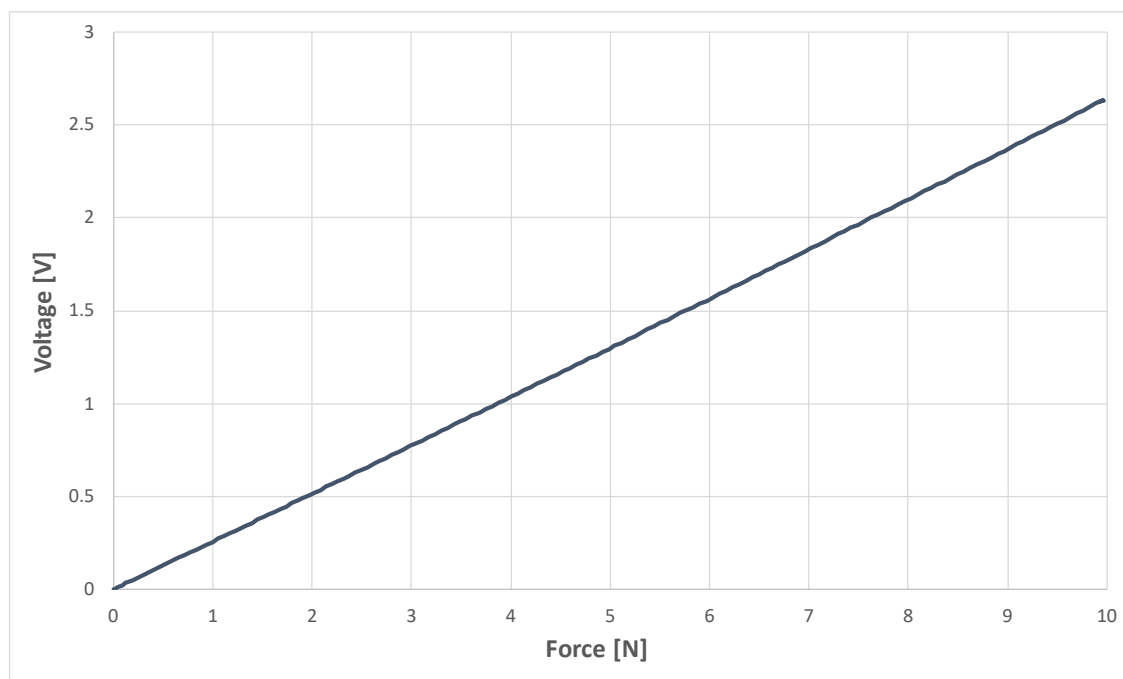

Fig. 8: Typical sensor characteristics open circuit voltage as a function of applied force



### PowerHap 1919 – Packaging

The minimum packaging quantity (30 pieces) consists of a single tray covered with conductive foam, and 2 empty trays (single tray: see Fig. 9). One of the empty trays is placed at the bottom and one at the top. The stack is fixed with tension belts and sealed in a transport bag before being placed in a cardboard box (external dimensions: 252 mm x 203 mm x 77 mm). A single package can be expanded with additional trays (up to 10) to contain a maximum of 300 pieces.

#### Dimensional drawing of a packaging tray

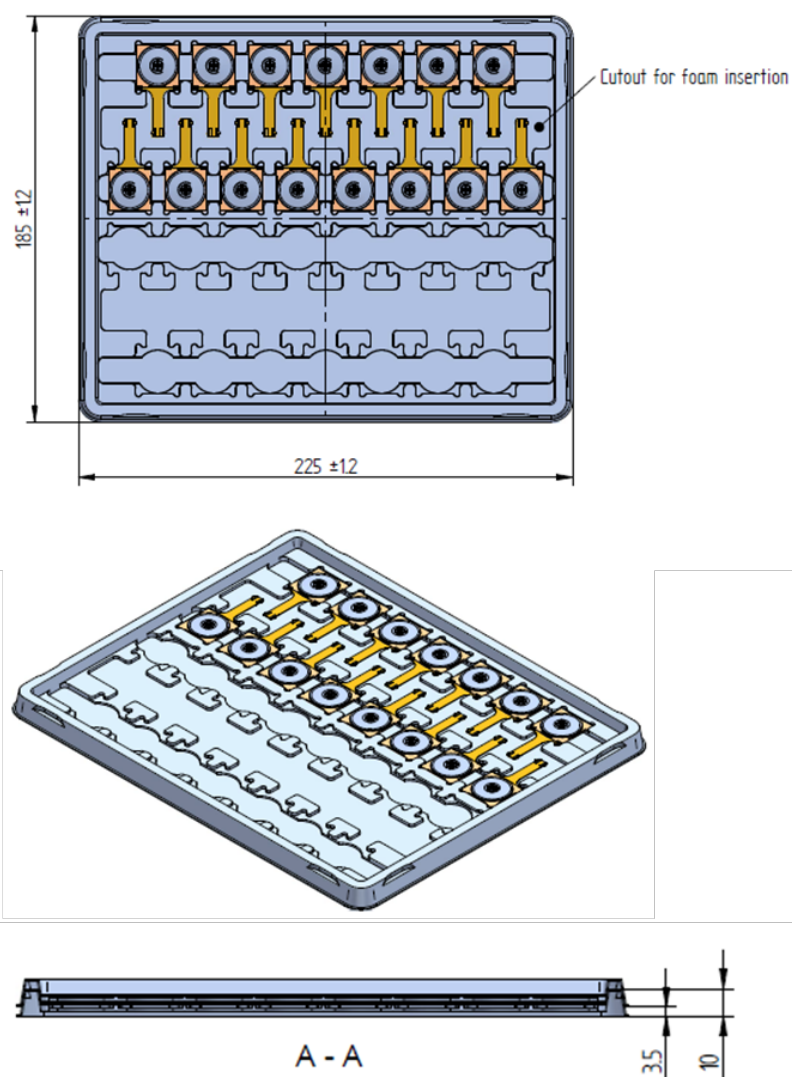
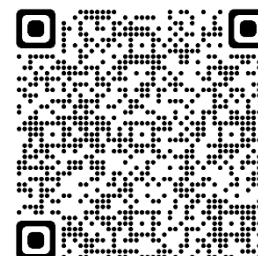

Fig. 9: Dimensional drawing of PowerHap 1919 packaging tray

## Integration guidelines

### 1. Design guide and reference example

General information concerning the mechanical system integration of PowerHap components can be found in the document “PowerHap Starter Kit Design Guide” (see QR code). The document details the integration of different PowerHap components contained in the PowerHap Starter Kit.



### 2. Mechanical integration

The actuator is to be mounted in a way so that the flat central parts of the two cymbals upon device operation exert forces perpendicular to the load side and the backing side interfaces, respectively. The acting interfaces with the opposing surfaces should encompass the whole flat central parts.

Adhesive mounting of the actuator to the contact surfaces on both sides is recommended. Double-sided pressure sensitive adhesive tapes are suitable in many cases. The thickness variation of adhesive tapes may be used for adjustment of tolerances in height direction.

In case that the actuator is mounted without adhesion only by clamping, care must be taken to avoid lateral dislocation of the actuator during operation.

The stiffness of the load side, seen from the actuator, should be low relative to the stiffness of the actuator (160 N/mm) to achieve high energy transfer and acceleration. This can be achieved by thinning to a membrane-like shape, or by mounting the load with flexible elements such as springs, grommets, or foam gaskets.

### 3. Explicit warning



- If under storage conditions temperature variations occur, the electrical contacts must be shortened.
- Operation of the PowerHap component outside of the defined specifications will lead to component failure and/or change of component parameters (e.g., displacement). If the component is exposed to temperatures exceeding the aforementioned temperature limit (see *General technical data*) and no component failure occurs, the displacement of the component may increase when operated again at standard operation conditions. The increase in displacement is only temporary and it will relax to the previous displacement after a few voltage cycles.

## General Notes

Some parts of this publication contain statements about the suitability of our ceramic piezo components for certain areas of application, including recommendations about incorporation/design-in of these products into customer applications. The statements are based on our knowledge of typical requirements made of our components in the particular areas. We nevertheless expressly point out that such statements cannot be regarded as binding statements about the suitability of our piezo components for a particular customer application. As a rule, TDK is either unfamiliar with individual customer applications or less familiar with them than the customers themselves. For these reasons, it is always incumbent on the customer to check and decide whether the piezo component components with the properties described in the product specification are suitable for use in a particular customer application.

- Do not use TDK piezo components for purposes not identified in our specifications, application notes and data sheets.
- Ensure the suitability of a piezo component in particular by testing it for reliability during design-in. Always evaluate a Piezo component under worst-case conditions.
- Pay special attention to the reliability of piezo components intended for use in safety-critical applications (e.g. medical equipment, automotive, spacecraft, nuclear power plant).
- Do not drive the piezo actuator under resonance conditions.

## Design notes

- Consider de-rating at higher operating temperatures and loads.
- In some cases, the malfunctioning of passive electronic components or failure before the end of their service life cannot be completely ruled out in the current state of the art, even if they are operated as specified. In applications requiring a very high level of operational safety and especially when the malfunction or failure of a passive electronic component could endanger human life or health (e.g. in accident prevention, life-saving systems, or automotive battery line applications such as clamp 30), ensure by suitable design of the application or other measures (e.g. installation of protective circuitry or redundancy) that no injury or damage is sustained by third parties in the event of such a malfunction or failure. Do not use piezo components in safety-relevant applications.
- Specified values only apply to piezo components that have not been subject to prior electrical, mechanical or thermal damage.

## Operation

- Use piezo actuator components only within the specified operating temperature range.
- Use piezo actuator components only within specified voltage and current ranges.
- Piezo actuator components have to be operated in a dry, non-reducing atmosphere which must not contain any additional chemical vapours or substances. We recommend appropriate drying of all components prior to hermetically sealing.
- Prevent a piezo actuator component from contacting liquids and solvents. Make sure that no water enters a piezo actuator component (e.g. through plug terminals).
- Avoid dewing and condensation.

- TDK piezo actuator components are mainly designed for encased applications. Under all circumstances avoid exposure to:
  - direct sunlight
  - rain or condensation
  - steam, saline spray
  - corrosive gases
  - atmosphere with reduced oxygen content.

We expressly point out that in case of non-observance of the aforesaid notes, in particular due to reasons attributable to chemical vapours, a malfunction or failure of the piezo actuator components before the end of their usual service life cannot be completely ruled out, even if they are operated as specified.

## Storage, handling and mounting instructions

### Storage

- Store the piezo actuator component with terminals short-circuited.
- Avoid contamination of the piezo actuator component surface during storage.
- Avoid storage of the piezo actuator components in harmful environments where they are exposed to corrosive gases (e.g. SO<sub>x</sub>, Cl).
- Storage conditions:  
Storage temperature: -25 °C to +45 °C  
Relative humidity (RH): ≤ 75% annual average, ≤ 95% on 30 days a year.  
Dew precipitation is inadmissible.
- Process piezo actuator components within 12 months after shipment from TDK.

### Handling

- Do not drop piezo actuator components or allow them to be chipped.
- During handling exert minimum force to the component.
- Do not touch piezo actuator component with bare hands, powderless nitrile gloves are recommended.
- Avoid contamination of the piezo actuator component surface during handling.

### Mounting

- Make sure the surface of the leads is not scratched before, during or after the mounting process.
- Make sure contacts and housings used for assembly with piezo actuator components are clean and dry before mounting.
- Avoid contamination of the surface of the piezo actuator component during processing.
- Make sure ceramic end surfaces are clean before the mounting process. We recommend short-circuiting the piezo actuator component during the whole mounting process.

## Cautions and warnings

- The piezo component must be operated in a dry, non-reducing, open environment and atmosphere which must not contain any chemical vapors or substances.
- To prevent damage on the piezo component, tensile stresses must be avoided under all driving conditions.
- We expressly point out that in case of non-observance of the aforesaid notes, due to reasons attributable to chemical vapors, a malfunction of the piezo sample or failure before the end of their usual service life cannot be completely ruled out, even if they are operated as specified.
- Depending on the individual application, piezo components are electrically connected to voltages and currents, which are potentially dangerous for life and health of the operator. Installation and operation of piezo components must be done only by authorized personnel. Ensure proper and safe connections, couplers, and drivers.
- Piezo components are highly efficient charge storing capacitors. Even when they are disconnected from a supply, the electrical energy content of a loaded actuator can be high and is maintained for a long time. Always ensure complete discharging of an actuator (e.g., via a 10 kΩ resistor) before handling. (Do not discharge by simple short-circuiting, because of the risk of damaging the ceramic.)
- Electrical charges can be generated on disconnected actuators by varying load or temperature. Discharge an actuator before connecting it to a measuring component/electronics, when this component is not sufficiently voltage proofed.
- During operation the driving signal should be chosen to avoid any excessive self-heating to ensure the component's temperature is within the operation temperature range stated in *General technical data* (page 2).
- The electrical connectivity of the piezo component is provided by a flexible printed circuit board (FPC). Excessive mechanical force on the FPC of the component during handling, exceeding the stated value in *General technical data* can lead to damage of the component. Furthermore, forces directed in directions not defined in *General technical data* can be significantly lower than the stated value. Therefore, special care is recommended during handling.
- All parameters defined in the tables of *General technical data* specify the delivery state of the component. Operation outside of the stated operation conditions can result in deviations of these parameters or failure of the component.
- In practice, electric circuits have leakage, resulting in the voltage output of the piezo, being also related to the speed of the applied force. This characteristic often makes it difficult to create a reliable touch sensor.

**This listing does not claim to be complete, but merely reflects the experience of TDK.**

## Display of ordering codes for TDK Electronics products

The ordering code for one and the same product can be represented differently in data sheets, data books, other publications, on the company website, or in order-related documents such as shipping notes, order confirmations and product labels. **The varying representations of the ordering codes are due to different processes employed and do not affect the specifications of the respective products.** Detailed information can be found on the Internet at [www.tdk-electronics.tdk.com/orderingcodes](http://www.tdk-electronics.tdk.com/orderingcodes).

## Important notes

The following applies to all products named in this publication:

1. Some parts of this publication contain **statements about the suitability of our products for certain areas of application**. These statements are based on our knowledge of typical requirements that are often placed on our products in the areas of application concerned. We nevertheless expressly point out **that such statements cannot be regarded as binding statements about the suitability of our products for a particular customer application**. As a rule we are either unfamiliar with individual customer applications or less familiar with them than the customers themselves. For these reasons, it is always ultimately incumbent on the customer to check and decide whether a product with the properties described in the product specification is suitable for use in a particular customer application.
2. We also point out that **in individual cases, a malfunction of electronic components or failure before the end of their usual service life cannot be completely ruled out in the current state of the art, even if they are operated as specified**. In customer applications requiring a very high level of operational safety and especially in customer applications in which the malfunction or failure of an electronic component could endanger human life or health (e.g. in accident prevention or life-saving systems), it must therefore be ensured by means of suitable design of the customer application or other action taken by the customer (e.g. installation of protective circuitry or redundancy) that no injury or damage is sustained by third parties in the event of malfunction or failure of an electronic component.
3. **The warnings, cautions and product-specific notes must be observed.**
4. In order to satisfy certain technical requirements, **some of the products described in this publication may contain substances subject to restrictions in certain jurisdictions (e.g. because they are classed as hazardous)**. Useful information on this will be found in our Material Data Sheets on the Internet ([www.tdk-electronics.tdk.com/material](http://www.tdk-electronics.tdk.com/material)). Should you have any more detailed questions, please contact our sales offices.
5. We constantly strive to improve our products. Consequently, **the products described in this publication may change from time to time**. The same is true of the corresponding product specifications. Please check therefore to what extent product descriptions and specifications contained in this publication are still applicable before or when you place an order.

We also **reserve the right to discontinue production and delivery of products**. Consequently, we cannot guarantee that all products named in this publication will always be available. The aforementioned does not apply in the case of individual agreements deviating from the foregoing for customer-specific products.

6. Unless otherwise agreed in individual contracts, **all orders are subject to our General Terms and Conditions of Supply**.
7. **Our manufacturing sites serving the automotive business apply the IATF 16949 standard**. The IATF certifications confirm our compliance with requirements regarding the quality management system in the automotive industry. Referring to customer requirements and customer specific requirements ("CSR") TDK always has and will continue to have the policy of respecting individual agreements. Even if IATF 16949 may appear to support the acceptance of unilateral requirements, we hereby like to emphasize that **only requirements mutually agreed upon can and will be implemented in our Quality Management System**. For clarification purposes we like to point out that obligations from IATF 16949 shall only become legally binding if individually agreed upon.

## Important notes

8. The trade names EPCOS, CarXield, CeraCharge, CeraDiode, CeraLink, CeraPad, CeraPlas, CSMP, CTVS, DeltaCap, DigiSiMic, FilterCap, FormFit, InsuGate, LeaXield, MediPlas, MiniBlue, MiniCell, MKD, MKK, ModCap, MotorCap, PCC, PhaseCap, PhaseCube, PhaseMod, PhiCap, PiezoBrush, PlasmaBrush, PowerHap, PQSine, PQvar, SIFERRIT, SIFI, SIKOREL, SilverCap, SIMDAD, SiMic, SIMID, SineFormer, SIOV, SurfIND, ThermoFuse, WindCap, XieldCap are **trademarks registered or pending** in Europe and in other countries. Further information will be found on the Internet at [www.tdk-electronics.tdk.com/trademarks](http://www.tdk-electronics.tdk.com/trademarks).

Release 2024-02