



Filters for power lines with HEMP-Protection according to MIL-STD 188-125-1

250/440 V, 50/60 Hz, 250...500 A

Series/Type: B84299C/D1251/1501E303/E313

Date: March 2024

© EPCOS AG 2024. Reproduction, publication and dissemination of this publication, enclosures hereto and the information contained therein without EPCOS' prior express consent is prohibited.

EPCOS AG is a TDK Group Company.

Filters for power lines with HEMP-Protection

250/440 V, 50/60 Hz, 250...500 A

B84299C/D1251/1501E303/E313

- 1-, 2- and 4-line filters 250 to 500 A
- Multi-stage
- Stopband attenuation 110 kHz to 40 GHz
- Tested according MIL-STD 188-125-1 (short and intermediate pulse)



Features

- General-purpose use through design with separate lines without intercoupling
- Use of single chokes. Thus the insertion loss values are not reduced under all operating current conditions and not when operated with artificial mains networks (AMN) or other equipment with high leakage currents
- Insertion loss to EN 55017

Design

The electrical components are incorporated in an RF-tight case of stainless steel. The cables enter through glands. The RF-tight termination of the openings is produced by specially shaped lids.

The conductors are connected by bus bars and equipment grounding conductor are connected by threaded bolts. The surface around the fixing holes is left as bare metal (unpainted) to ensure good RF contact with metal surfaces (chassis, ground).

Protective measures (grounding)

The high capacitances between the lines and ground require special protective measures. If there are no product-specific requirements, protection with a secondary ground wire (cross section min. 10 mm²) in accordance with EN 50178 is necessary. For this purpose the filter case have connecting bolts at each end.

Resistors are incorporated in the filter to discharge capacitors after turn-off.

Scope of supply

Filters are supplied complete with all parts required for RF-tight installation (fixing screws, flanges, RF gaskets, cable glands) and installation instructions.

Installation

No welding is needed on the shielding wall, so any subsequent installation is quite simple.

Accessories and special versions

RF-tight flexible connector fittings are available for installation spaced away from the shielding wall. To match requirements, filters can be supplied with different kinds of EMC or shielding cable glands.

Tests

All filters are 100% tested and the results are archived under a filter's serial number. If required, a test report can be generated for the serial number.

Filters for power lines with HEMP-Protection
250/440 V, 50/60 Hz, 250...500 A
B84299C/D1251/1501E303/E313
Technical data and measuring conditions

Rated voltage	V_R [L-PE / L-L]	250/440 V AC (50/60 Hz)
Rated frequency	f_R	50/60 Hz
Rated current	I_R	See characteristics
Power dissipation	P_D	See characteristics
Test voltage line to line for 2 s ¹⁾	V_{test}	1200 V DC
Test voltage line to case for 2 s ¹⁾	V_{test}	1200 V DC
Rated temperature	T_R	40 °C
Overload capability (thermal)	I_{over}	75 × I_R for 50 ms 10 × I_R for 1 s 2 × I_R for 1 min 1.4 × I_R for 15 min
Reactive current of each phase line at 230/400 V	$I_{reactive}$	At U_R and 50 Hz, see characteristics
Leakage current (IEC 60939-1: 2010, Annex A)	I_{LK}	At U_R and 50 Hz, see characteristics
Max. permissible harmonic distortion (THD)	THD_{max}	8% according to EN 50160
Climatic category (IEC 60068-1: 1992)		25/085/56
Permissible ambient temperature		-25 ... +40 °C
Degree of protection (IEC 60529: 2013)		IP 20
Max. DC resistance	R_{DC}	See characteristics

1) EMP-protection components disconnected

Filters for power lines with HEMP-Protection
250/440 V, 50/60 Hz, 250...500 A
B84299C/D1251/1501E303/E313
Characteristics and ordering codes

I_R	Mech. version ¹⁾	Terminal	R_{DC}	P_D	$I_{reactive}$	I_{LK}	Dimensional drawing	Circuit diagram	Appr. weight	Ordering code
A			m Ω	W	A	mA			kg	
Filter for assembly from outside to the shielded wall										
4 × 250	C	Bus bar	< 0.5	95	2.2	230	1	1	75	B84299C1251E303
	D						2			B84299D1251E303
2 × 500	C		< 0.25	125	4.4	460 ²⁾	3	2		B84299C1501E303
	D					4	B84299D1501E303			
Filter for assembly from inside to the shielded wall										
4 × 250	C	Bus bar	< 0.5	95	2.2	230	5	3	75	B84299C1251E313
	D						6			B84299D1251E313
2 × 500	C		< 0.25	125	4.4	460 ²⁾	7	4		B84299C1501E313
	D					8	B84299D1501E313			

1) Connection to the shielding

C = at front side

D = at bottom side

2) Total leakage current of 2 Filters used in a 3phase+N System

Filters for power lines with HEMP-Protection

250/440 V, 50/60 Hz, 250...500 A

B84299C/D1251/1501E303/E313

Assembly of filters

Filters B84299CxxxxE303 for assembly from outside to the shielded wall

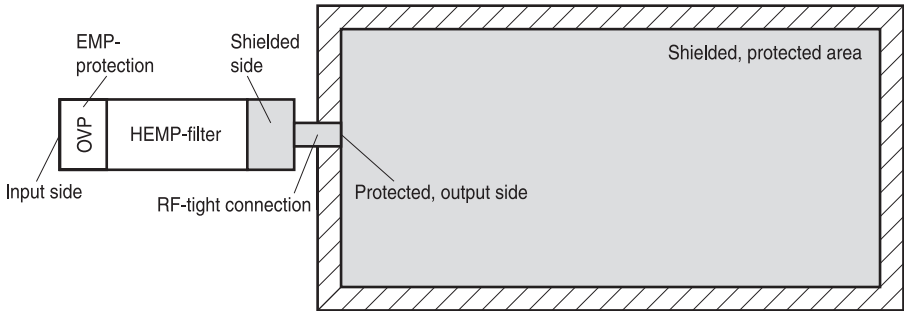

SSB2921-Y-E

Filters B84299DxxxxE303 for assembly from outside to the shielded wall

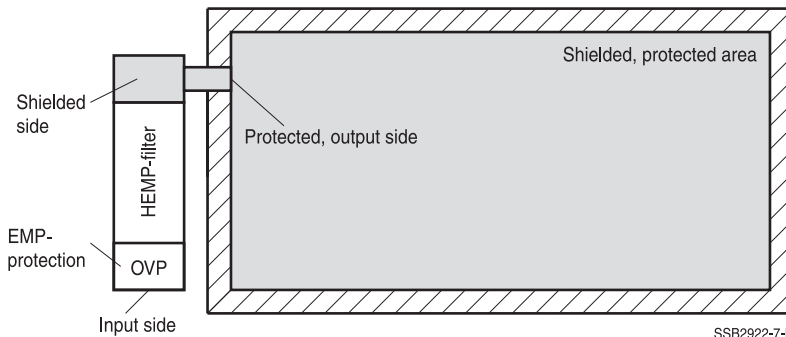

SSB2922-7-E

Filters B84299CxxxxE313 for assembly from inside to the shielded wall

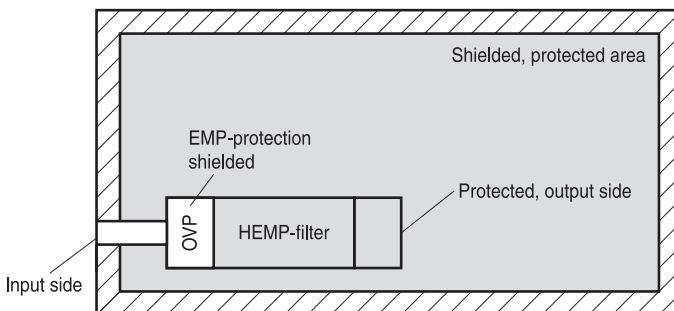

SSB2923-F-E

Filters for power lines with HEMP-Protection

250/440 V, 50/60 Hz, 250...500 A

B84299C/D1251/1501E303/E313

Filters B84299DxxxxE313 for assembly from inside to the shielded wall

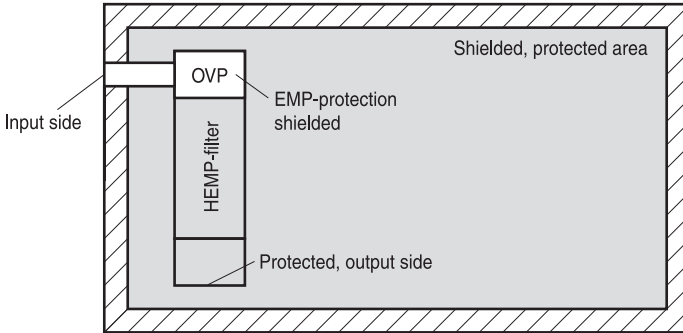

SSB2924-N-E

Approvals / Test reports acc. to MIL-STD 188-125-1

Ordering code	Test report from EMCCons DR. RAŠEK GmbH & Co. KG www.emcc.de Test acc. MIL-STD 188-125-1 (short and intermediate pulse test)		
Filter for assembly from outside to the shielded wall			
B84299...		Response current Short pulse	Response current intermediate pulse
...C1251E303	Test report EMCC-860009.1DBA, 2016-09-28	3.41 A max.	17.75 A
...D1251E303	Test report EMCC-860009.1DBA, 2016-09-28		
...C1501E303	Test report EMCC-860009.1FBA, 2016-09-28	8.52 A max.	42.66 A
...D1501E303	Test report EMCC-860009.1FBA, 2016-09-28		
Filter for assembly from inside to the shielded wall			
...C1251E313	Test report EMCC-860009.1DBA, 2016-09-28	3.41 A max.	17.75 A
...D1251E313	Test report EMCC-860009.1DBA, 2016-09-28		
...C1501E313	Test report EMCC-860009.1FBA, 2016-09-28	8.52 A max.	42.66 A
...D1501E313	Test report EMCC-860009.1FBA, 2016-09-28		

Filters for power lines with HEMP-Protection

250/440 V, 50/60 Hz, 250...500 A

B84299C/D1251/1501E303/E313

Circuit diagram 1: B84299C1251E303 (4 × 250 A), B84299D1251E303 (4 × 250 A)

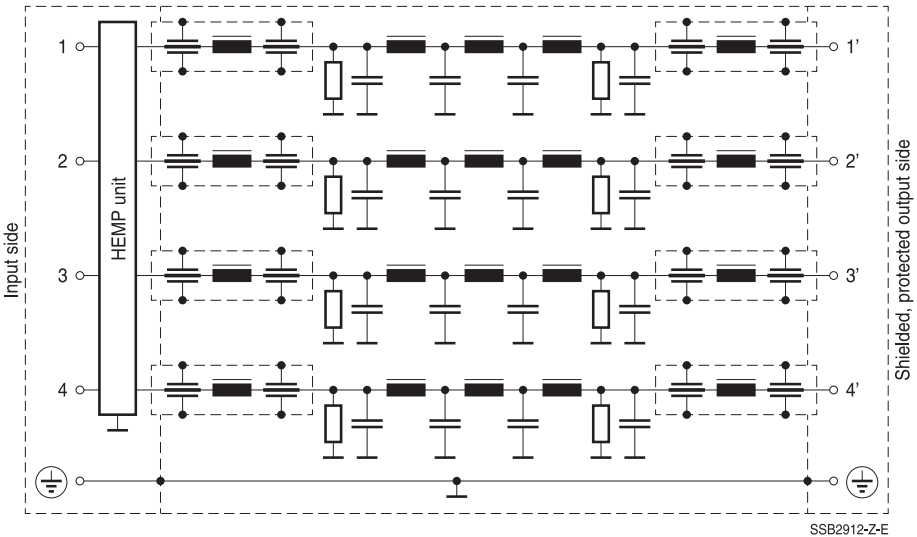

Circuit diagram 2: B84299C1501E303 (2 × 500 A), B84299D1501E303 (2 × 500 A)

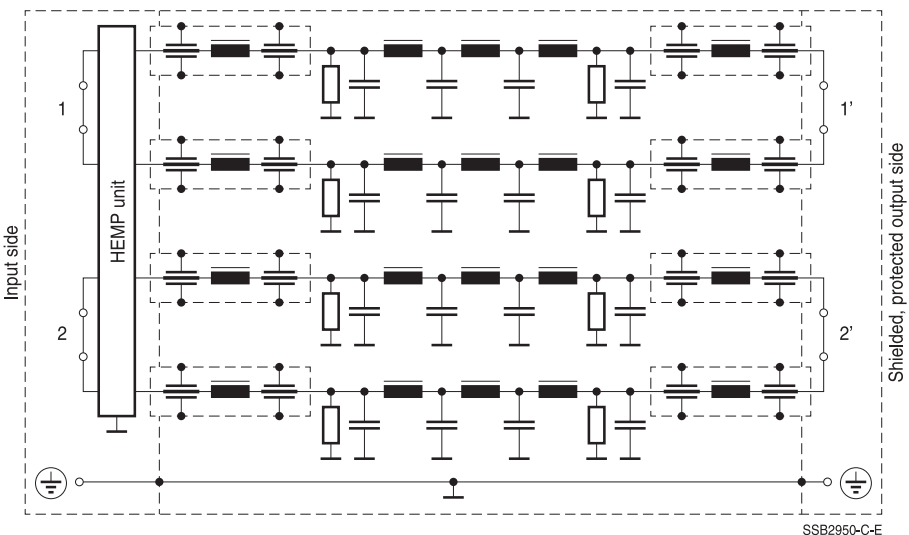

Filters for power lines with HEMP-Protection

250/440 V, 50/60 Hz, 250...500 A

B84299C/D1251/1501E303/E313

Circuit diagram 3: B84299C1251E313 (4 × 250 A), B84299D1251E313 (4 × 250 A)

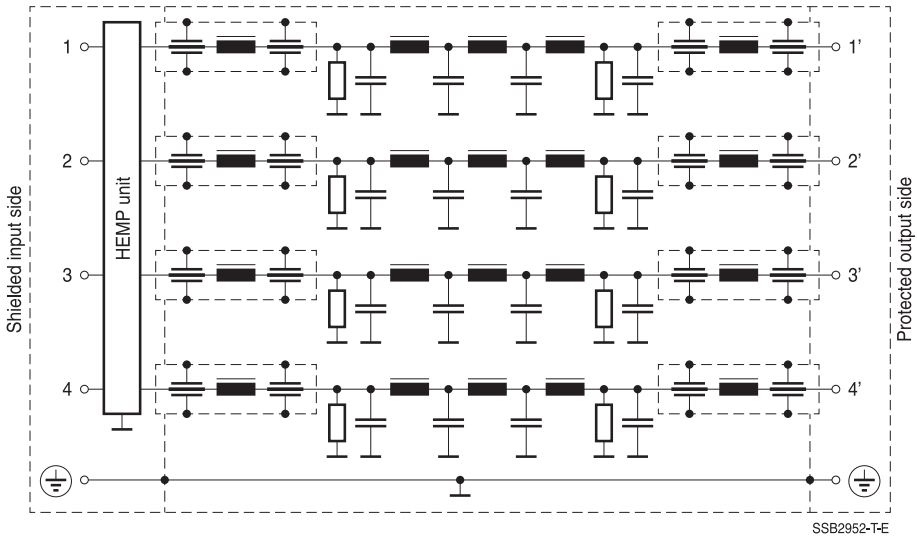

Circuit diagram 4: B84299C1501E313 (2 × 500 A), B84299D1501E313 (2 × 500 A)

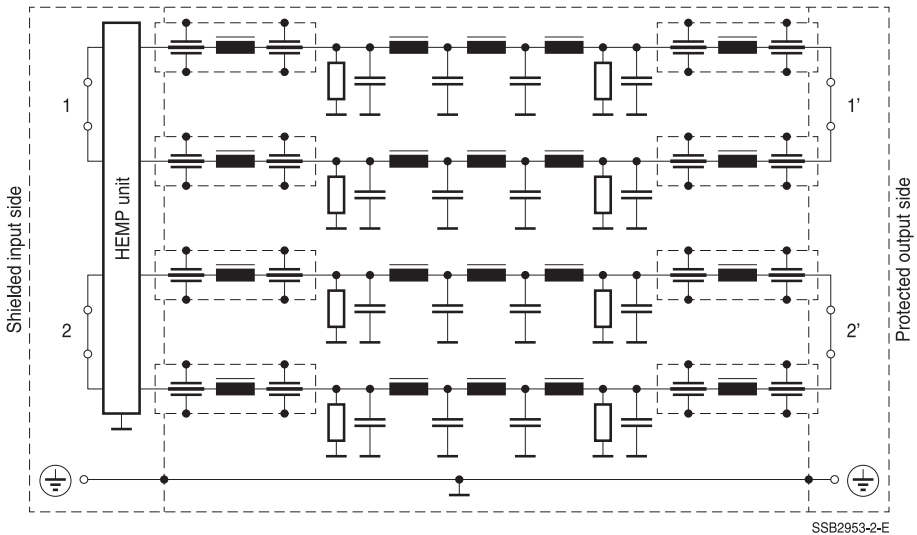

Filters for power lines with HEMP-Protection

250/440 V, 50/60 Hz, 250...500 A

B84299C/D1251/1501E303/E313

Insertion loss a_e as a function of frequency f (typical values at $Z = 50 \text{ Ohm}$)

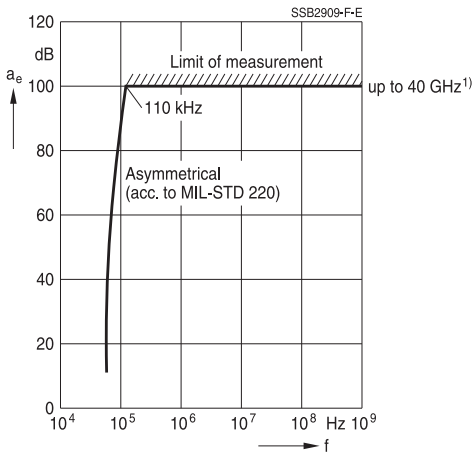

¹⁾ According to MIL-STD 285

Shielding effectiveness of filter housing acc. MIL-STD 188-125-1/2

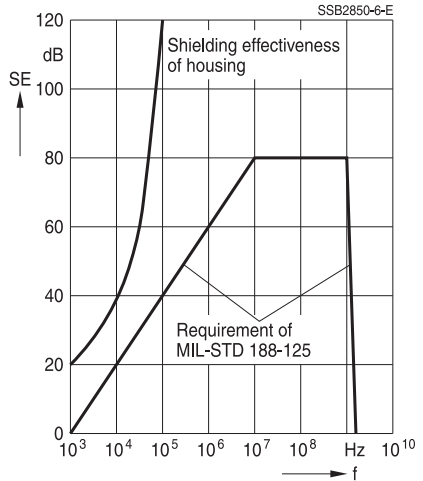

Test setup

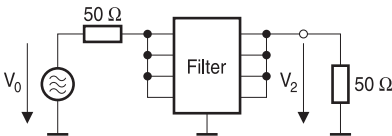

$$a_e = 20 \lg \frac{V_0}{2 V_2} \text{ [dB]}$$

SSB2846-D-E

Filters for power lines with HEMP-Protection

250/440 V, 50/60 Hz, 250...500 A

B84299C/D1251/1501E303/E313

Dimensional drawings

Drawing 1 – B84299C1251E303 (4 × 250 A) for assembly from outside to the shielded wall

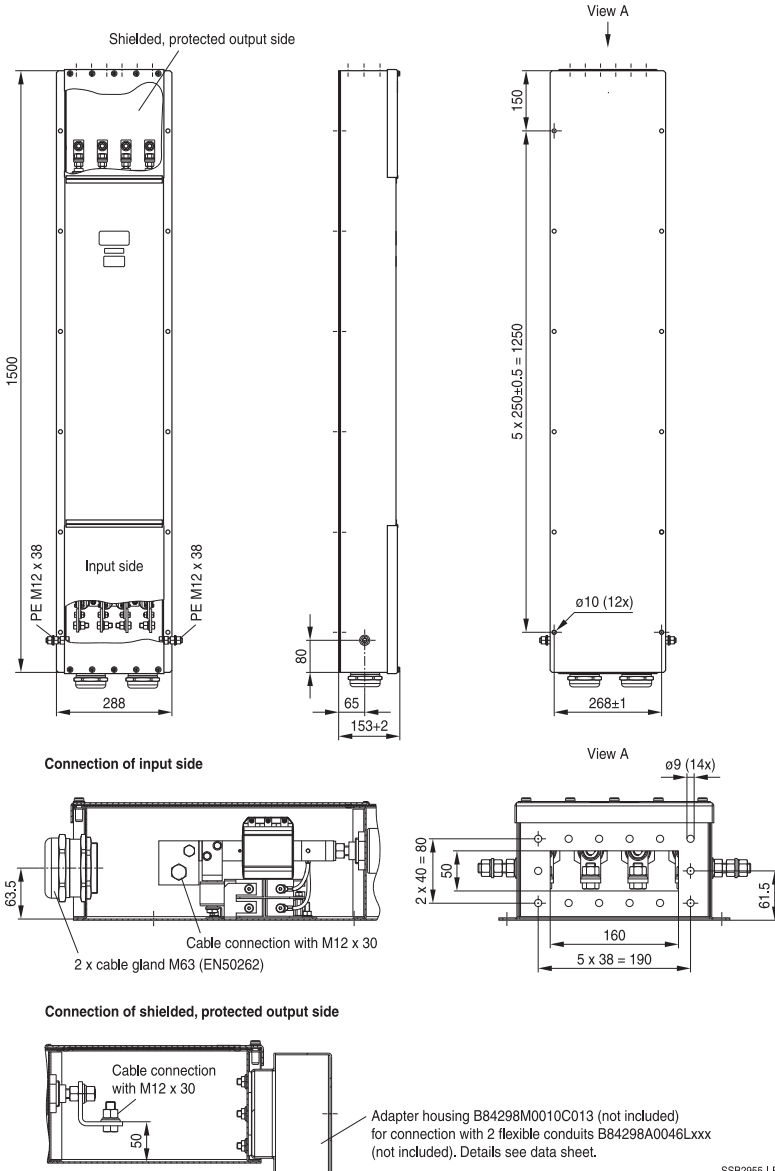

SSB2955-I-E

Filters for power lines with HEMP-Protection

250/440 V, 50/60 Hz, 250...500 A

B84299C/D1251/1501E303/E313

Drawing 2 – B84299D1251E303 (4 × 250 A) for assembly from outside to the shielded wall

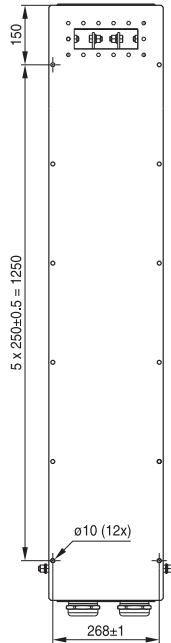
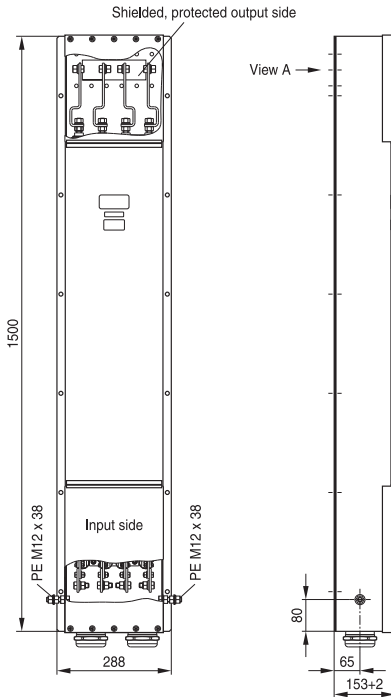

Connection of input side

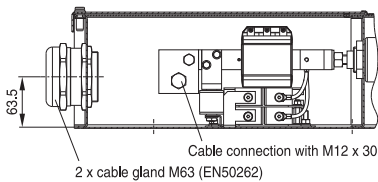

Connection of shielded, protected output side

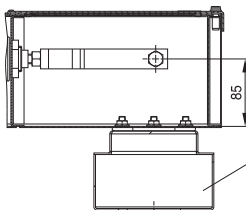

Adapter housing B84298M0010C013 (not included)
for connection with 2 flexible conduits B84298A0046Lxxx
(not included). Details see data sheet.

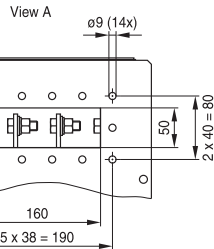

Filters for power lines with HEMP-Protection

250/440 V, 50/60 Hz, 250...500 A

B84299C/D1251/1501E303/E313

Drawing 3 – B84299C1501E303 (2 × 500 A) for assembly from outside to the shielded wall

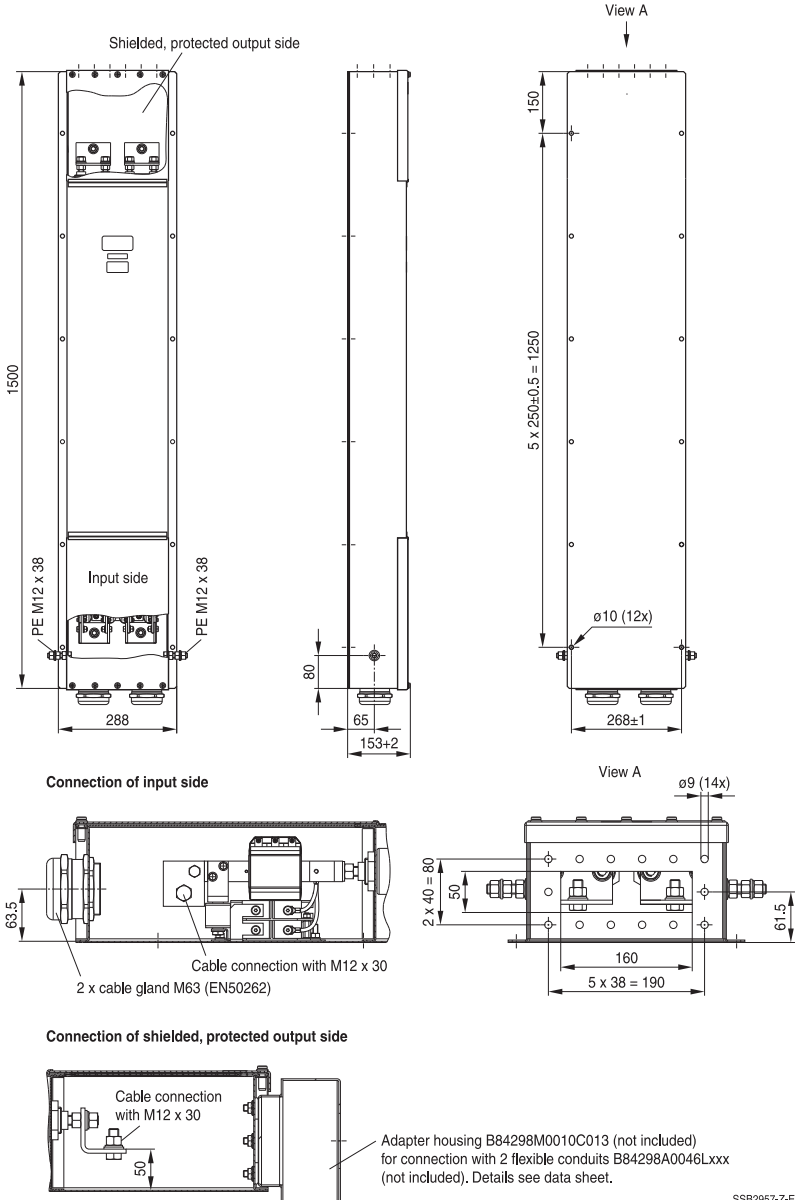

SSB2957-Z-E

Filters for power lines with HEMP-Protection

250/440 V, 50/60 Hz, 250...500 A

B84299C/D1251/1501E303/E313

Drawing 4 – B84299D1501E303 (2 × 500 A) for assembly from outside to the shielded wall

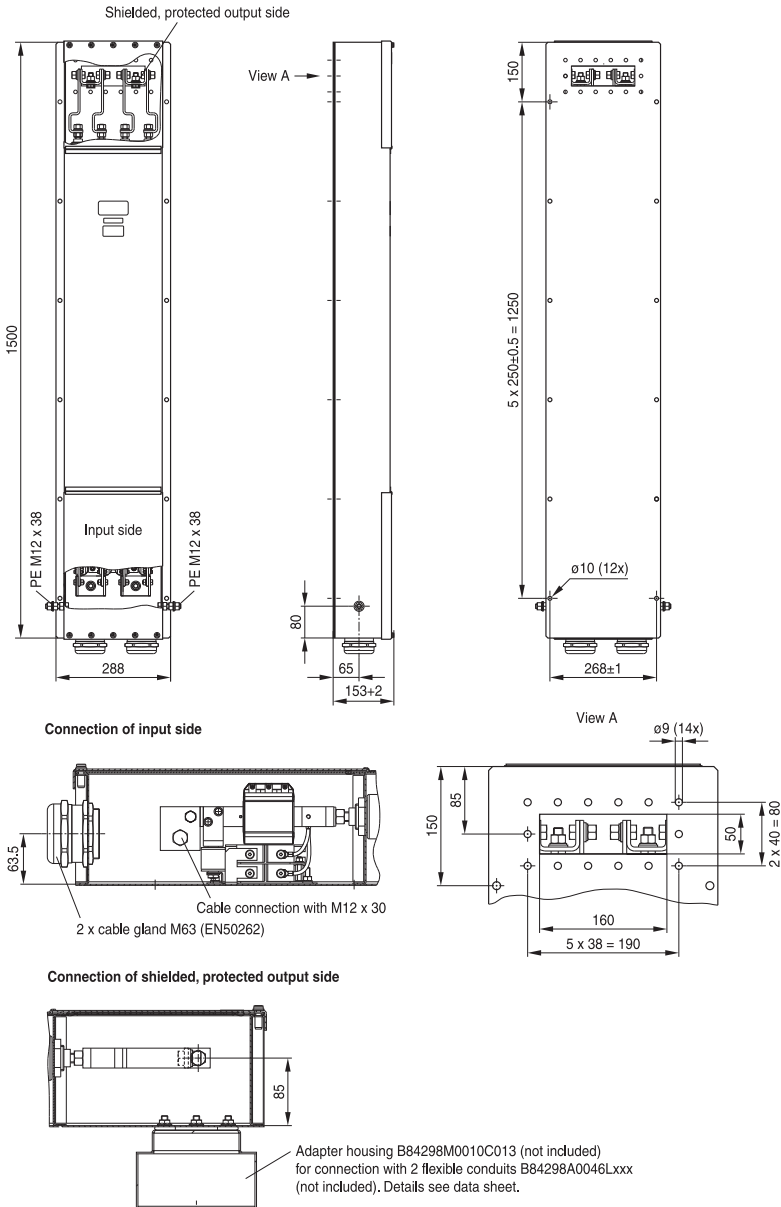

SSB2958-8-E

Filters for power lines with HEMP-Protection

250/440 V, 50/60 Hz, 250...500 A

B84299C/D1251/1501E303/E313

Drawing 5 – B84299C1251E313 (4 × 250 A) for assembly from inside to the shielded wall

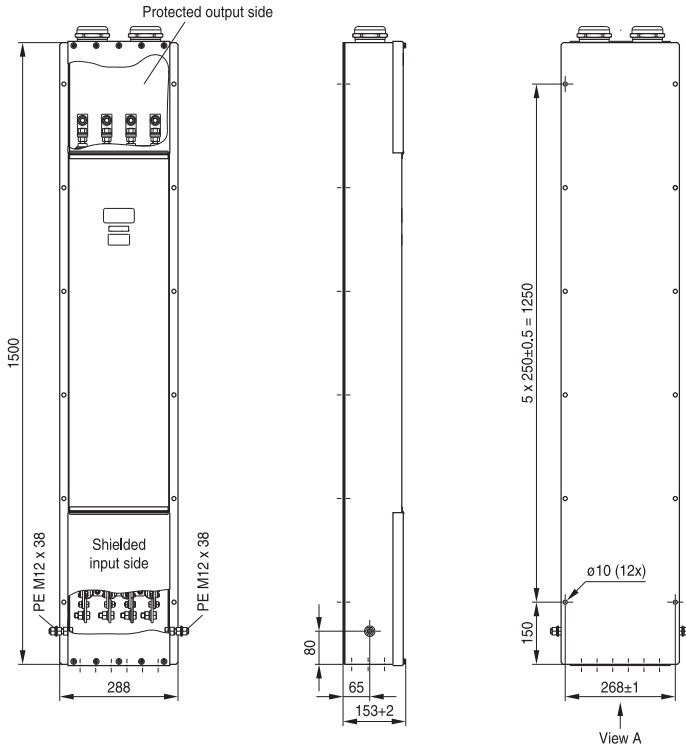

Connection of protected output side

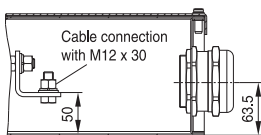

Connection of shielded input side

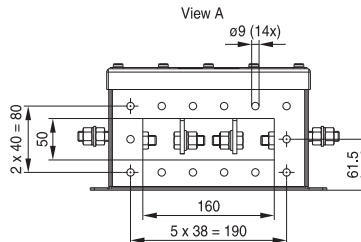
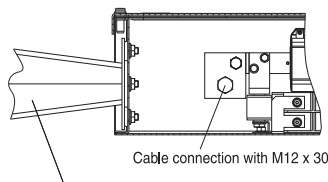

Adapter housing B84298M0010C011 (not included) for welding to the shielded wall. Details see data sheet.

SSB2961-S-E

Filters for power lines with HEMP-Protection

250/440 V, 50/60 Hz, 250...500 A

B84299C/D1251/1501E303/E313

Drawing 6 – B84299D1251E313 (4 × 250 A) for assembly from inside to the shielded wall

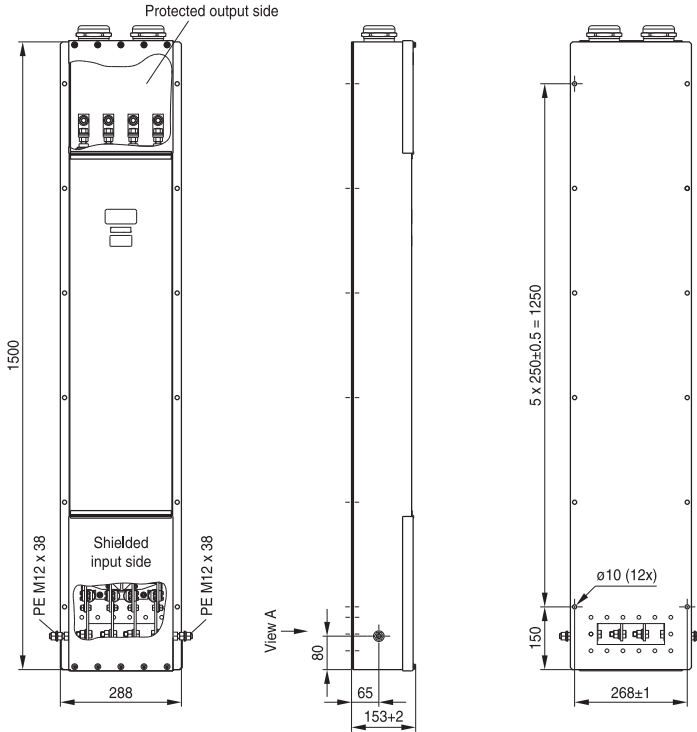

Connection of protected output side

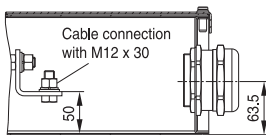

Connection of shielded input side

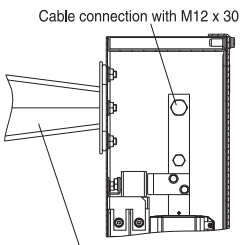

View A

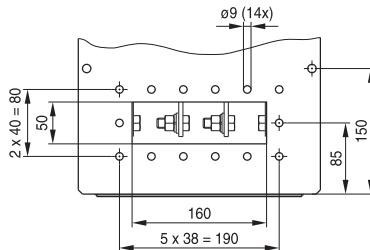

Adapter housing B84298M0010C011 (not included)
for welding to the shielded wall.
Details see data.

SSB2962-1-E

Filters for power lines with HEMP-Protection

250/440 V, 50/60 Hz, 250...500 A

B84299C/D1251/1501E303/E313

Drawing 7 – B84299C1501E313 (2 × 500 A) for assembly from inside to the shielded wall

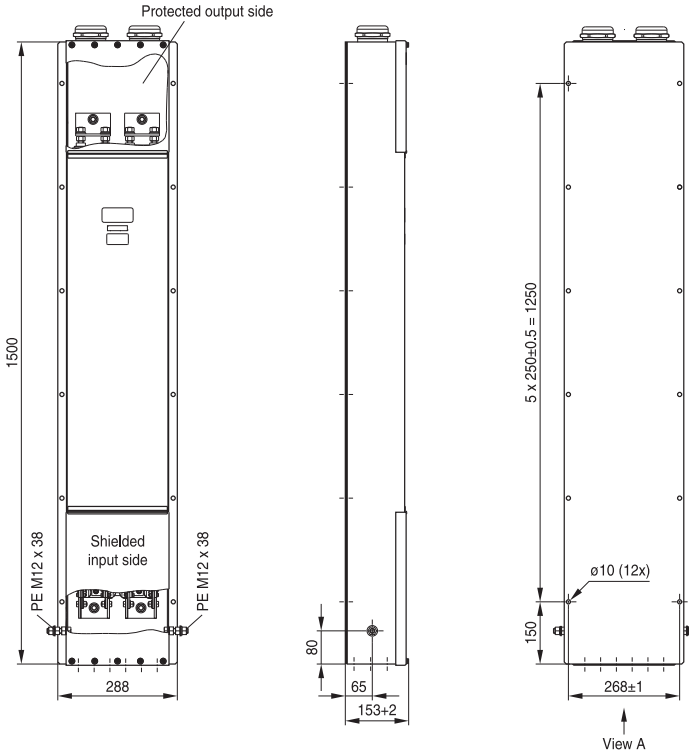

Connection of protected output side

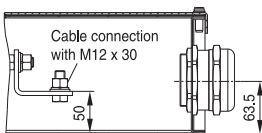

Connection of shielded input side

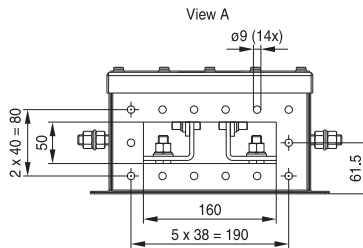
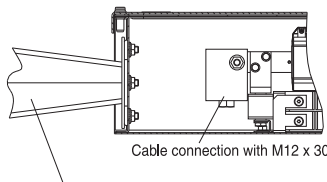

Adapter housing B84298M0010C011 (not included) for welding to the shielded wall. Details see data sheet.

SSB2963-9-E

Filters for power lines with HEMP-Protection

250/440 V, 50/60 Hz, 250...500 A

B84299C/D1251/1501E303/E313

Drawing 8 – B84299D1501E313 (2 × 500 A) for assembly from inside to the shielded wall

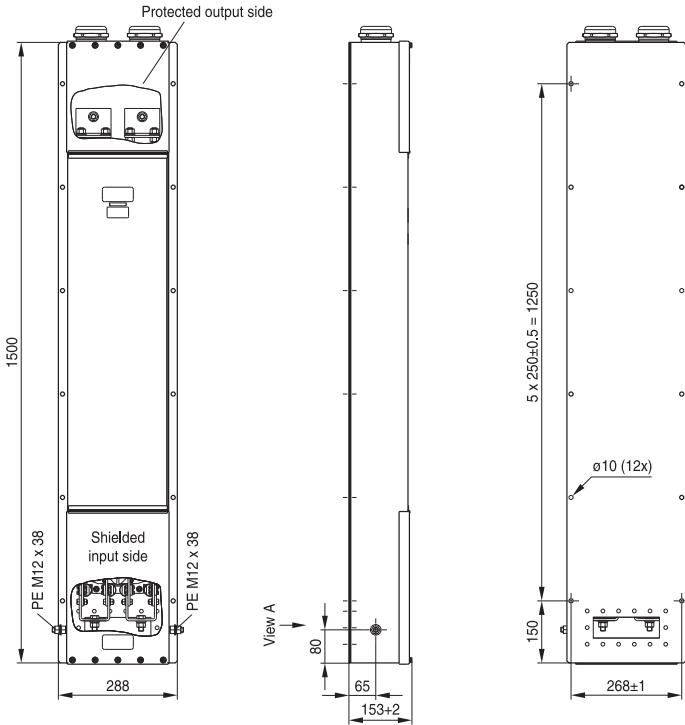

Connection of protected output side

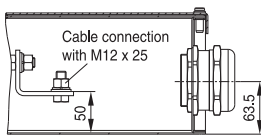

Connection of shielded input side

Cable connection with M12 x 30

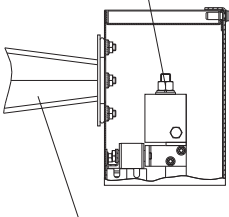

Adapter housing B84298M0010C011 (not included)
for welding to the shielded wall.
Details see data sheet.

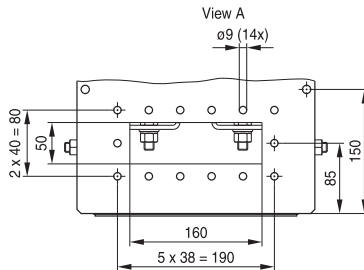

SSB2964+H-E

Filters for power lines with HEMP-Protection

Cautions and warnings

B84299C/D1251/1501E303/E313

Please read all safety and warning notes carefully before installing the filter and putting it into operation. The same applies to the warning signs on the filter. Please ensure that the signs are not removed nor their legibility impaired by external influences.

Death, serious bodily injury and substantial material damage to equipment may occur if the appropriate safety measures are not carried out or the warnings in the text are not observed.

Using according to the terms

The filters may be used only for their intended application within the specified values in low voltage networks in compliance with the instructions given in the data sheets and the data book.

The conditions at the place of application must comply with all specifications for the filter used.

Warning

- It shall be ensured that only qualified persons (electricity specialists) are engaged on work such as planning, assembly, installation, operation, repair and maintenance. They must be provided with the corresponding documentation.
- Danger of electric shock. Filters contain components that store an electric charge. Dangerous voltages can continue to exist at the filter terminals for longer than five minutes even after the power has been switched off
- The protective earth connections shall be the first to be made when the filter is installed and the last to be disconnected. Depending on the magnitude of the leakage currents, the particular specifications for making the protective earth connection must be observed.
- Impermissible overloading of the filter or filter, such as with circuits able to cause resonances, impermissible voltages at higher frequencies etc. can lead to bodily injury and death as well as cause substantial material damages (e.g. destruction of the filter housing).
- Filters must be protected in the application against impermissible exceeding of the rated currents by overcurrent protective devices.
- In case of leakage currents >3.5 mA you shall mount the PE conductor stationary with the required cross section before beginning of operation and save it against disconnecting. For leakage currents $I_L^{(1)} \leq 10$ mA the PE conductor must have a KU value²⁾ of 4.5³⁾; for leakage currents $I_L > 10$ mA the PE conductor must have a KU value of 6⁴⁾.
- Because the product can become very hot during operation, there is the risk of burns if touched. The product can remain hot for some time after the power is switched off!

Display of ordering codes for EPCOS products

The ordering code for one and the same EPCOS product can be represented differently in data sheets, data books, other publications, on the EPCOS website, or in order-related documents such as shipping notes, order confirmations and product labels. **The varying representations of the ordering codes are due to different processes employed and do not affect the specifications of the respective products.** Detailed information can be found on the Internet under www.epcos.com/orderingcodes

1) I_L = leakage current let-go

2) The KU value (symbol KU) is a classification parameter of safety-referred failure types designed to ensure protection against hazardous body currents and excessive heating.

3) $I_L = A$ value of $KU = 4.5$ with respect to interruptions is attained with: a) permanently connected protective earth connection ≥ 1.5 mm² and b) a protective earth connection ≥ 2.5 mm² via connectors for industrial equipment (IEC 6030902)

4) $KU = 6$ with respect to interruptions is achieved for fixed-connection lines ≥ 10 mm² where the type of connection and installation correspond to the requirements for PEN conductors as specified in relevant standards.

Filters for power lines with HEMP-Protection
Symbols and terms
B84299C/D1251/1501E303/E313

Symbol	English	German
dv/dt	Rate of voltage rise	Spannungsanstiegsgeschwindigkeit
f_R	Rated frequency	Bemessungsfrequenz
f_{Pass}	Passband	
I_{LK}	Filter leakage current	Filter-Ableitstrom
$I_{reactive}$	Capacitive reactive current	Kapazitiver Blindstrom
I_N	Nominal current	Nennstrom
I_R	Rated current	Bemessungsstrom
I_{over}	Overcurrent	Überstrom
P_D	Power dissipation	Verlustleistung
R_I	Internal resistance	Innenwiderstand
R_{DC}	Maximum DC resistance	Max. Gleichstromwiderstand (Gleichspannung)
T_A	Ambient temperature	Umgebungstemperatur
T_D	Transverse delay time	
T_R	Rated temperature	Bemessungstemperatur
THD_{max}	Max. permissible harmonic distortion	
V_{br}	Breakdown voltage	
V_{cl}	Max. clamping voltage	
V_N	Nominal network voltage	Netzspannung
V_{test}	Test voltage	Prüfspannung
V_R	Rated voltage	Bemessungsspannung
Z	Impedance	Scheinwiderstand
Z_L	Line impedance	Leitungsimpedanz
α_e	Insertion loss	Einfügungsdämpfung
ΔV	Voltage drop	Spannungsabfall

The following applies to all products named in this publication:

1. Some parts of this publication contain **statements about the suitability of our products for certain areas of application**. These statements are based on our knowledge of typical requirements that are often placed on our products in the areas of application concerned. We nevertheless expressly point out **that such statements cannot be regarded as binding statements about the suitability of our products for a particular customer application**. As a rule we are either unfamiliar with individual customer applications or less familiar with them than the customers themselves. For these reasons, it is always ultimately incumbent on the customer to check and decide whether a product with the properties described in the product specification is suitable for use in a particular customer application.
2. We also point out that **in individual cases, a malfunction of electronic components or failure before the end of their usual service life cannot be completely ruled out in the current state of the art, even if they are operated as specified**. In customer applications requiring a very high level of operational safety and especially in customer applications in which the malfunction or failure of an electronic component could endanger human life or health (e.g. in accident prevention or life-saving systems), it must therefore be ensured by means of suitable design of the customer application or other action taken by the customer (e.g. installation of protective circuitry or redundancy) that no injury or damage is sustained by third parties in the event of malfunction or failure of an electronic component.
3. **The warnings, cautions and product-specific notes must be observed.**
4. In order to satisfy certain technical requirements, **some of the products described in this publication may contain substances subject to restrictions in certain jurisdictions (e.g. because they are classed as hazardous)**. Useful information on this will be found in our Material Data Sheets on the Internet (www.tdk-electronics.tdk.com/material). Should you have any more detailed questions, please contact our sales offices.
5. We constantly strive to improve our products. Consequently, **the products described in this publication may change from time to time**. The same is true of the corresponding product specifications. Please check therefore to what extent product descriptions and specifications contained in this publication are still applicable before or when you place an order. We also **reserve the right to discontinue production and delivery of products**. Consequently, we cannot guarantee that all products named in this publication will always be available. The aforementioned does not apply in the case of individual agreements deviating from the foregoing for customer-specific products.
6. Unless otherwise agreed in individual contracts, **all orders are subject to our General Terms and Conditions of Supply**.

7. **Our manufacturing sites serving the automotive business apply the IATF 16949 standard.**
The IATF certifications confirm our compliance with requirements regarding the quality management system in the automotive industry. Referring to customer requirements and customer specific requirements (“CSR”) TDK always has and will continue to have the policy of respecting individual agreements. Even if IATF 16949 may appear to support the acceptance of unilateral requirements, we hereby like to emphasize that **only requirements mutually agreed upon can and will be implemented in our Quality Management System**. For clarification purposes we like to point out that obligations from IATF 16949 shall only become legally binding if individually agreed upon.
8. The trade names EPCOS, CarXield, CeraCharge, CeraDiode, CeraLink, CeraPad, CeraPlas, CSMP, CTVS, DeltaCap, DigiSiMic, FilterCap, FormFit, InsuGate, LeaXield, MediPlas, MiniBlue, MiniCell, MKD, MKK, ModCap, MotorCap, PCC, PhaseCap, PhaseCube, PhaseMod, PhiCap, PiezoBrush, PlasmaBrush, PowerHap, PQSine, PQvar, SIFERRIT, SIFI, SIKOREL, SilverCap, SIMDAD, SiMic, SIMID, SineFormer, SIOV, SurfIND, ThermoFuse, WindCap, XieldCap are **trademarks registered or pending** in Europe and in other countries. Further information will be found on the Internet at www.tdk-electronics.tdk.com/trademarks.

Release 2024-02