



Pressure Sensor Transmitters

Series/Type: B58620T

The following products presented in this data sheet are being withdrawn.

Ordering Code	Substitute Product	Date of Withdrawal	Deadline Last Orders	Last Shipments
B58620T0520A005		2025-04-04	2025-07-17	2025-10-18
B58621K0520A005		2025-04-04	2025-07-17	2025-10-18
B58621K0520A006		2025-04-04	2025-07-17	2025-10-18
B58621K0520A007		2025-04-04	2025-07-17	2025-10-18

Please contact your nearest TDK sales office if you need support in selecting a suitable substitute. The addresses of our worldwide sales network are presented at www.tdk-electronics.tdk.com/sales.

Pressure sensors

Pressure transmitters without stainless steel casing (current output) CAU-T series

Description

- TDK pressure transmitters are based on our inhouse designed and produced piezo-resistive pressure sensing elements (MEMS Technology).
- The T-series electronic compensates non-linearity and temperature errors and supplies a highly accurate calibrated output signal with a high immunity against electromagnetic influences (EMI).

Features

- Suitable media for absolute measurement:
Air, non-aggressive gases (gas humidity 0...85% r.h., without dew)
Unsuitable for substances which react with glass, silicon, gold, aluminum, stainless steel, silicone glue or silicone gel.
- Suitable media for gauge measurement:
Air, non-aggressive gases (gas humidity 0...100% r.h.) and non-aggressive fluids.
Unsuitable for substances which react with glass, silicon, stainless steel, NBR, silicone glue ($p_r \leq 10$ bar) or epoxy glue ($p_r > 10$ bar).
- 2-wire current output proportional to pressure: 4...20 mA
- Reverse supply voltage protection
- RoHS-compatible
- Compact casing (protection IP00)



Dimensional drawings

**Type KC for gauge pressure
(M5 thread connection)**

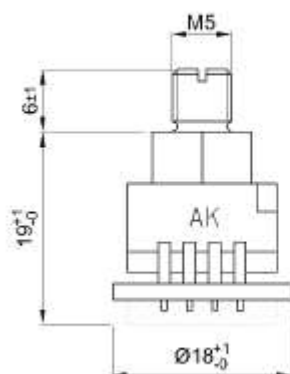

**Type TH for absolute pressure
(M5 thread connection)**

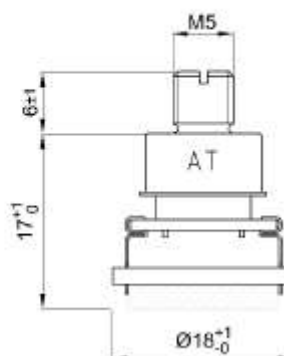

Dimensions in mm

Pressure sensors

Pressure transmitters without stainless steel casing (current output) CAU-T series

1. Technical data

Absolute maximum ratings

Parameter	Symbol	Conditions	Min.	Typ.	Max.	Unit
Temperature ranges						
Storage temperature range	T _{st}	¹⁾	-40		+105	°C
Operating temperature range	T _a	²⁾	-25		+85	°C
Compensated temperature range	T _c	³⁾	0		+70	°C
Soldering temperature (cable)	T _{solder}	<5 s (no reflow soldering)			+240	°C
Pressure ranges						
Over pressure	p _{ov}	⁴⁾⁵⁾	1.5			p _r
Supply voltage /-current						
Supply voltage	V _{CC}	See connection diagram ⁶⁾	10		30	V
Current limit (p >> p _r)	I _{CCMAX}		23			mA
Output signal at sensor failure	I _{ERR}				3	mA
Load resistance	R _L	See connection diagram ⁷⁾			1000	Ohm
DC voltage resistance	V _{is}	⁸⁾	500			V

Parameter	Symbol	Conditions	Min.	Typ.	Max.	Unit
Output signal @ T_a = 25 °C, V_s = 15 V, R_L = 100 Ω						
Offset	I _{CC0}	Simple output AUA, AUR ⁹⁾	3.92	4.0	4.08	mA
		Symmetrical output AUS ⁹⁾	11.92	12.0	12.08	mA
Signal span (Full Scale)	I _{FS}	¹⁰⁾	15.92	16.0	16.08	mA
Non-linearity	L	Simple output ^{10) 11)}		±0.1	±0.25	% FS
		Symmetrical output ^{10) 11)}		±0.25	±0.5	% FS
Response time	t ₁₀₋₉₀	¹²⁾		1		ms
Supply voltage rejection	SVR	^{10) 13)}			±0.01	%FS/V

Parameter	Symbol	Conditions	Min.	Typ.	Max.	Unit
Data in temperature range @ T_a = 25...85 °C, V_s = 15 V, R_L = 100 Ω						
Temperature hysteresis		¹⁴⁾		±0.1	±0.5	% FS
Data in temperature range @ T_a = 0...70 °C, V_s = 15 V, R_L = 100 Ω						
Temperature coefficient of offset	TCI _{CC0}	p _r < 0.25 bar ¹⁵⁾		±0.015	±0.05	% FS/K
		p _r ≥ 0.25 bar ¹⁵⁾		±0.015	±0.03	% FS/K
Temperature coefficient of span	TCI _{FS}	¹⁶⁾		±0.015	±0.03	% FS/K

Pressure sensors

Pressure transmitters without stainless steel casing (current output) CAU-T series

2. Characteristics

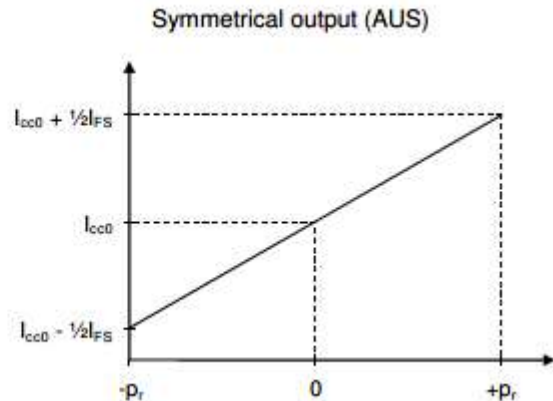
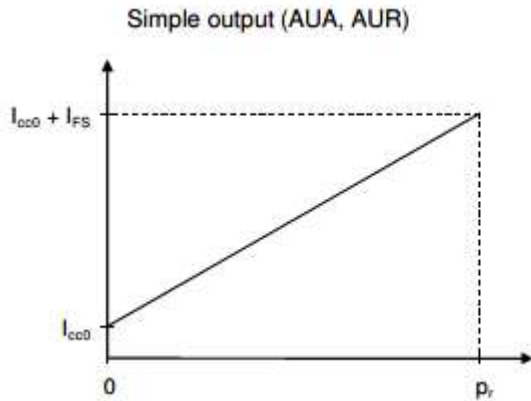

3. Connection diagram and conditions

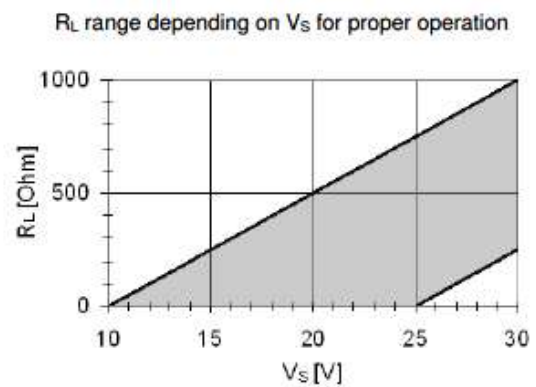
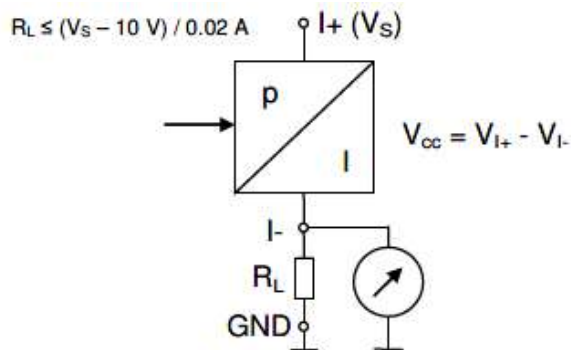

4. Terminal assignment (view to soldering side)

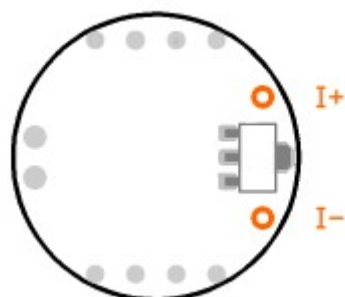

Pressure sensors

Pressure transmitters without stainless steel casing (current output) CAU-T series

5. Type designation

Rated pressure and ordering codes				
Pressure measurement	Absolute	Gauge		
		2.500	6.000	10.00
Rated pressure p _r bar	25.00	2.500	6.000	10.00
Product type	AJA 25.00 TH C4 TN H P	AUR 2.500 KC C4 TN H P	AUR 6.000 KC C4 TN H P	AUR 10.00 KC C4 TN H S2.0
Ordering code	B58620T0520A005	B58621K0520A005	B58621K0520A006	B58621K0520A007

Other rated pressures upon request

6. Symbols and terms

1) Storage temperature range T_{st}

A storage of the pressure sensor within the temperature range $T_{st,min}$ up to $T_{st,max}$ and without applied pressure and supply voltage will not affect the performance of the pressure sensor.

2) Operating temperature range T_a

An operation of the pressure sensor within the temperature range $T_{a,min}$ up to $T_{a,max}$ will not affect the performance of the pressure sensor.

3) Compensated temperature range T_c

While operating the pressure sensor within the temperature range $T_{c,min}$ up to $T_{c,max}$, the deviation of the output signal from the values at 25 °C will not exceed the temperature coefficients. Out of the compensated temperature range, the deviations may increase.

4) Rated pressure p_r

Within the rated pressure range 0 up to p_r (symmetrical output: $-p_r$ up to $+p_r$) the signal output characteristic corresponds to this specification.

5) Over pressure p_{ov}

Pressure cycles within the pressure range 0 up to p_{ov} will not affect the performance of the pressure sensor.

6) Supply voltage V_{CC}

$V_{CC,max}$ is the maximum permissible supply voltage, which can be applied without damages. $V_{CC,min}$ is the minimum required supply voltage, which has to be applied for normal operation.

7) Load resistance R_L

Depending on V_S , the maximum working resistance is $R_L \leq (V_S - 10 V) / 0.02 A$.

8) DC voltage resistance V_{is}

The pressure sensor withstands a high voltage between the stainless steel pressure connection and the electrical connection I+ and I- (short circuited) without damage.

9) Offset I_{CC0}

The offset I_{CC0} is the signal output I_{CC} ($p = 0$) at zero pressure.

10) Signal span (Full Scale)

Simple output: $I_{FS} = FS = I_{CC}(p_r) - I_{CC0}$

Symmetrical output: $I_{FS} = FS = I_{CC}(+p_r) - I_{CC}(-p_r)$

11) Non-linearity L (including pressure hysteresis)

The non-linearity is the deviation of the real sensor characteristic $I_{CC} = f(p)$ from the ideal straight line.

It can be approximated by a polynomial of second order, with the maximum at $p_x = p_r / 2$.

The equation to calculate the non-linearity is:

$$L = \frac{I_{CC}(p_x) - I_{CC0} - \frac{p_x}{p_r} (I_{CC}(p_r) - I_{CC0})}{I_{CC}(p_r) - I_{CC0}}$$

12) Response time

Delay between a pressure change (10...90% p_r) and the corresponding signal output change (10...90% FS).

13) Supply voltage rejection SVR

While varying the supply voltage within the range $V_{CC,min}$ up to $V_{CC,max}$ at constant pressure and temperature, the signal output change will not exceed SVR_{max} .

14) Temperature hysteresis

The temperature hysteresis is the change of offset, starting from the value at 25 °C after a temperature change and return to 25 °C. Determined during temperature cycles in operating temperature range (cycles with 1 K/min).

15) Temperature coefficients of offset TCl_{CC0}

Offset at temperature T_x : $I_{CC0}(T_x) = I_{CC0}(25\text{ °C}) + I_{FS}(25\text{ °C}) \cdot TCl_{CC0}$

Values are valid within the compensated temperature range $T_{c,min}$ up to $T_{c,max}$

Out of the compensated temperature range, the deviation may increase.

16) Temperature coefficients of span TCl_{FS}

Span at temperature T_x : $I_{FS}(T_x) = I_{FS}(25\text{ °C}) \cdot [1 + (T_x - 25\text{ °C}) \cdot TCl_{FS}]$

Values are valid within the compensated temperature range $T_{c,min}$ up to $T_{c,max}$

Out of the compensated temperature range, the deviation may increase.

Cautions and warnings

Storage (general)

All pressure sensors should be stored in their original packaging. They should not be placed in harmful environments such as corrosive gases nor exposed to heat or direct sunlight, which may cause deformations. Similar effects may result from extreme storage temperatures and climatic conditions. Avoid storing the sensor dies in an environment where condensation may form or in a location exposed to corrosive gases, which will adversely affect their performance. Plastic materials should not be used for wrapping/packing when storing or transporting these dies, as they may become charged. Pressure sensor dies should be used soon after opening their seal and packaging.

Operation (general)

Media compatibility with the pressure sensors must be ensured to prevent their failure. The use of other media can cause damage and malfunction. Never use pressure sensors in atmospheres containing explosive liquids or gases.

Ensure pressure equalization to the environment, if gauge pressure sensors are used. Avoid operating the pressure sensors in an environment where condensation may form or in a location exposed to corrosive gases. These environments adversely affect their performance.

If the operating pressure is not within the rated pressure range, it may change the output characteristics. This may also happen with pressure sensor dies if an incorrect mounting method is used. Be sure that the applicable pressure does not exceed the over pressure, as it may damage the pressure sensor.

Do not exceed the maximum rated supply voltage nor the rated storage temperature range, as it may damage the pressure sensor.

Temperature variations in both the ambient conditions and the media (liquid or gas) can affect the accuracy of the output signal from the pressure sensors. Be sure to check the operating temperature range and thermal error specification of the pressure sensors to determine their suitability for the application.

Connections must be wired in accordance with the terminal assignment specified in the data sheets. Care should be taken as reversed pin connections can damage the pressure transmitters or degrade their performance. Contact between the pressure sensor terminals and metals or other materials may cause errors in the output characteristics.

Design notes (dies)

This specification describes the mechanical, electrical and physical requirements of a piezoresistive sensor die for measuring pressure. The specified parameters are valid for the pressure sensor die with pressure application either to the front or back side of the diaphragm as described in the data sheet. Pressure application to the other side may result in differing data. Most of the parameters are influenced by assembly conditions. Hence these parameters and the reliability have to be specified for each specific application and tested over its temperature range by the customer.

Pressure sensors

Pressure transmitters without stainless steel casing (current output) CAU-T series

Handling/ Mounting (dies)

Pressure sensor dies should be handled appropriately and not be touched with bare hands. They should only be picked up manually by the sides using tweezers. Their top surface should never be touched with tweezers. Latex gloves should not be used for handling them, as this will inhibit the curing of the adhesive used to bond the die to the carrier. When handling, be careful to avoid cuts caused by the sharp-edged terminals. The sensor die must not be contaminated during manufacturing processes (gluing, soldering, silk-screen process).

The package of pressure sensor dies should not to be opened until the die is mounted and should be closed after use. The sensor die must not be cleaned. The sensor die must not be damaged during the assembly process (especially scratches on the diaphragm).

Soldering (transducers, transmitters)

The thermal capacity of pressure sensors is normally low, so steps should be taken to minimize the effects of external heat. High temperatures may lead to damage or changes in characteristics.

A non-corrosive type of flux resin should normally be used and complete removal of the flux is recommended. Avoid rapid cooling due to dipping in solvent. Note that the output signal may change if pressure is applied to the terminals during soldering.

This listing does not claim to be complete, but merely reflects the experience of TDK Electronics AG.

Display of ordering codes for TDK Electronics products

The ordering code for one and the same product can be represented differently in data sheets, data books, other publications, on the company website, or in order-related documents such as shipping notes, order confirmations and product labels. **The varying representations of the ordering codes are due to different processes employed and do not affect the specifications of the respective products.** Detailed information can be found on the Internet under www.tdk-electronics.tdk.com/orderingcodes.

Important notes

The following applies to all products named in this publication:

1. Some parts of this publication contain **statements about the suitability of our products for certain areas of application**. These statements are based on our knowledge of typical requirements that are often placed on our products in the areas of application concerned. We nevertheless expressly point out **that such statements cannot be regarded as binding statements about the suitability of our products for a particular customer application**. As a rule we are either unfamiliar with individual customer applications or less familiar with them than the customers themselves. For these reasons, it is always ultimately incumbent on the customer to check and decide whether a product with the properties described in the product specification is suitable for use in a particular customer application.
2. We also point out that **in individual cases, a malfunction of electronic components or failure before the end of their usual service life cannot be completely ruled out in the current state of the art, even if they are operated as specified**. In customer applications requiring a very high level of operational safety and especially in customer applications in which the malfunction or failure of an electronic component could endanger human life or health (e.g. in accident prevention or life-saving systems), it must therefore be ensured by means of suitable design of the customer application or other action taken by the customer (e.g. installation of protective circuitry or redundancy) that no injury or damage is sustained by third parties in the event of malfunction or failure of an electronic component.
3. **The warnings, cautions and product-specific notes must be observed.**
4. In order to satisfy certain technical requirements, **some of the products described in this publication may contain substances subject to restrictions in certain jurisdictions (e.g. because they are classed as hazardous)**. Useful information on this will be found in our Material Data Sheets on the Internet (www.tdk-electronics.tdk.com/material). Should you have any more detailed questions, please contact our sales offices.
5. We constantly strive to improve our products. Consequently, **the products described in this publication may change from time to time**. The same is true of the corresponding product specifications. Please check therefore to what extent product descriptions and specifications contained in this publication are still applicable before or when you place an order.

We also **reserve the right to discontinue production and delivery of products**. Consequently, we cannot guarantee that all products named in this publication will always be available. The aforementioned does not apply in the case of individual agreements deviating from the foregoing for customer-specific products.

6. Unless otherwise agreed in individual contracts, **all orders are subject to our General Terms and Conditions of Supply**.
7. **Our manufacturing sites serving the automotive business apply the IATF 16949 standard**. The IATF certifications confirm our compliance with requirements regarding the quality management system in the automotive industry. Referring to customer requirements and customer specific requirements ("CSR") TDK always has and will continue to have the policy of respecting individual agreements. Even if IATF 16949 may appear to support the acceptance of unilateral requirements, we hereby like to emphasize that **only requirements mutually agreed upon can and will be implemented in our Quality Management System**. For clarification purposes we like to point out that obligations from IATF 16949 shall only become legally binding if individually agreed upon.

Important notes

8. The trade names EPCOS, CeraCharge, CeraDiode, CeraLink, CeraPad, CeraPlas, CSMP, CTVS, DeltaCap, DigiSiMic, ExoCore, FilterCap, FormFit, LeaXield, MiniBlue, MiniCell, MKD, MKK, MotorCap, PCC, PhaseCap, PhaseCube, PhaseMod, PhiCap, PowerHap, PQSine, PQvar, SIFERRIT, SIFI, SIKOREL, SilverCap, SIMDAD, SiMic, SIMID, SineFormer, SIOV, ThermoFuse, WindCap are **trademarks registered or pending** in Europe and in other countries. Further information will be found on the Internet at www.tdk-electronics.tdk.com/trademarks.

Release 2018-10